



Office and home office
management

Addressing and
shipping

Pricing and product
identification

Production and
logistics

Outdoor
applications

Decorative
identification

Free templates and
software

A4 labels

For laser printers, copiers
and inkjet printers

Quality from the outset - from the raw material to the label

HERMA bundles the entire competence of self-adhesive technology.



Research and development: in our **own laboratory** we develop and test **new solutions** for label applications.



The **self-adhesive material** for HERMA labels is produced on **state-of-the-art** coating machines. Quality right from the start.



Labels - manufactured with **extreme precision**: for maximum security during printing and trouble-free application.



Short distances from the raw material to the label: saves transport and conserves resources. Everything in one place. **Made in Germany.**

Contents

Everything at a glance

HERMA quality and innovation	4-5
Software Solutions	6-7
Themes	8-13
Materials	14
Product range by format	15-19
Universal/Address labels	20-23
File spine labels	24-27
Permanent file spine labels	24-25
Removable file spine labels	26
File spine labels made of recycled paper	27
Inkjet file spine labels	27
Spine insert labels	43
Data storage	28-29
CD labels	28
Inkjet CD labels	28
Video, slide, diskettes, zip labels	29
CD/DVD inlays	29
Identification	30-60
Removable labels	30-32
Repositionable address and shipping labels	30
Power labels	33
Coloured labels	34
Neon labels	35
Labels made of recycled paper with the Blue Angel ecolabel	36
Address labels made of recycled paper	36
Labels made of silphie paper	37
Inkjet labels	38-40
Inkjet address labels	38
Weatherproof film labels for inkjet printers	39
Bottle labels	39
Glossy labels	39
High-gloss labels	41
Name labels, textile labels	42
Weather-resistant labels	44
Outdoor film labels	45
Weatherproof film labels	46
Weatherproof shipping labels	46
Weatherproof film labels, yellow	46
Weatherproof film labels, removable	47
Rating plates	48
Security labels	49
Seal labels	49
Transparent address labels	50
Transparent film labels	50
Silver film labels	51
QR code labels	52
Correction/covering labels	52
Deep-freeze labels	53
Labels for shipping or warning notes	53
Shipping label + delivery note	53
Jewellery labels	54
Robust tags	54
Home A4-series 5 and 10 sheets	55-57
Hygiene assortment/instruction labels	58
Multipurpose labels for hand lettering	59-61
Search & Find	62-63

Themes

Discover the applications

Office management	8
Addressing/Shipping	9
Pricing and product labelling	10
Production and logistics	11
Outdoor applications	12
Decorative identification	13

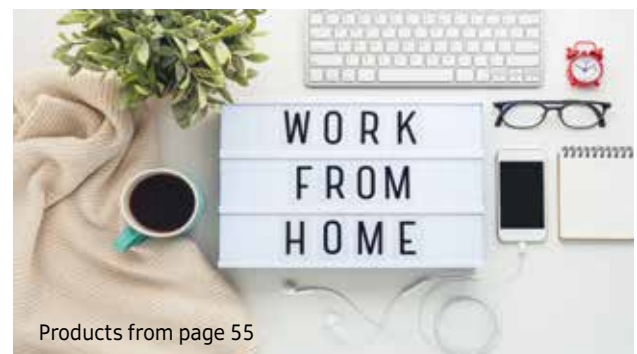

Products from page 55

10-sheet packs for working from home

Small pack, ideal for small label quantities!

Time-saving and economical!

Address labels, folder labels, name labels, and much more. Special materials such as type plates and removable film labels are also available in the practical 10-sheet pack.

More information: www.herma.com/10-sheet-packs

Sustainable for the environment: HERMA will be climate neutral!

From 2021 all direct emissions will be carbon neutral

Our development and manufacturing will leave no carbon footprint.

Following the internationally recognised Greenhouse Gas Protocol.

Our direct emissions will be climate neutral (scope 1 and 2).

100 % green electricity from renewable energies, only "green gas".

Heat recovery sustainably reduces energy consumption.

Offset our emissions by participating in environmental and social projects with myclimate.



We are protecting forests and conserving resources

Environmentally friendly labels in best quality

FSC™-certified label material:
from responsibly managed forests

Solvent-free, water-based adhesives:
acid-free, plasticiser-free

Recyclable labels with
„Blue Angel“ certification

Labels and backing material
recyclable with waste paper

Learn more:
www.herma.com/quality

Look out for FSC™
certified products.



Quality is in every detail

For highest processing reliability and best printing results

Tested and approved.

HERMA labels are regularly subjected to rigorous tests on all common printers.

We make every effort to ensure smooth running and top-quality printing results. Leading printer manufacturers honour our high quality with approval certificates and recommendations.

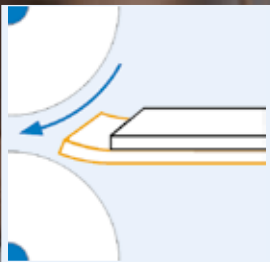

No paper dust thanks to cleanly cut edges on all sides

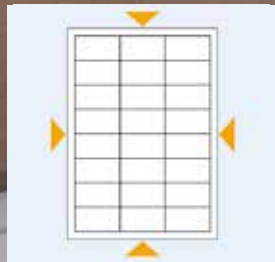

No adhesive deposits thanks to all-round protective edge

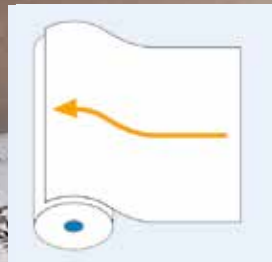

Trouble-free running thanks to optimum flatness and high flexibility



Climate-proof package: protects the contents from harm caused by moisture and temperature



Certified manufacturing

TÜV SÜD has certified us according to ISO 9001:2008 for the development, production and distribution of labels and adhesive materials.

Software solutions from HERMA

free, simple and fast: www.herma.com/office-home/free-software



HERMA Label Assistant Online

No programme download, no software installation

Available round the clock – design online, print locally

Ideal for company networks but also for private users

Select a format, design a label, print PDF – done

Works on all operating systems and with all current Internet browsers

Always up-to-date with all HERMA label formats

HERMA Label Assistant Online

The functions will convince you - as will the results!



HERMA Label Assistant Online

Design assistant: Step by step to the finished label. With preview function

Serial printing of address labels from Excel, in just 3 steps to the result

Upload your own photos or logos. Visible in real preview on the screen

Time-saving template management: save and print templates online

Barcodes and QR codes in just a few clicks: Enter internet address or EAN code – done. Can be combined with mail merge













Video tutorials and help videos on our homepage



www.herma.com/lao

Wide range of design templates - can be changed individually

Ready-to-use: select design and label format, design, print!

 <p>Company Name Tel: +3 3574768 www.herma.com 100 Avenue Charles, LA</p>	 <p>06</p>	 <p>CD COMPANY</p>	 <p>HAND MADE</p>
Address labels, design 3 Article number / Format 8634 (70x42,4 mm) Design online	spine label, background stone Article number / Format 5135 (81x297 mm) Design online	CD labels, firm presentation Article number / Format 5115 (116x116 mm) Design online	Gift label, heart, round, white Article number / Format 5066 (60x60 mm) Design online
 <p>Happy Christmas</p>	 <p>HERMA ORIGINAL AID HAPPY NEW YEAR</p>	 <p>SPECIAL OFFER</p>	 <p>David HAPPY BIRTHDAY</p>
Colorful christmas balls Article number / Format 8882 (90x120 mm) Design online	Deer petrol Article number / Format 8882 (90x120 mm) Design online	Pricing, actions, special, red Article number / Format 4667 (96x50,8 mm) Design online	Name labels/plates, birthday, colour, blue Article number / Format 8012 (90x60 mm) Design online
 <p>James King Box Meer 100 4860 Cologne City</p>	 <p>Handmade WITH LOVE</p>	 <p>ABSTAND HALTEN KEEP DISTANCE</p>	 <p>Face Mask Sign</p>
Christmas tree and stars Article number / Format 8832 (63,5x38,1 mm) Design online	Gift label, branch, background chalk Article number / Format 3067 (60x60 mm) Design online	Sign keep distance, german and english Article number / Format 10314 (199,6x143,5 mm) Design online	Face Mask Sign Article number / Format 4478 (85x85 mm) Design online

Choose from a wide range of themes:

- Address labels and shipping notes
- File labels and CD labels
- Gift and greeting labels
- Bottle labels
- Name labels/Badges
- Product and price labels
- Signs and corona notices
- Heart shaped labels



Format templates for Word, InDesign and Illustrator

Can be used directly in your usual software without installation.



www.herma.com/office-home/free-software

Download free of charge

Simple search via item number or label format

Dimensionally accurate templates - no need to measure labels

For all HERMA label formats on A4, A5 and A6 sheets

Pre-designed designs for Microsoft Word: open file, adapt, print - done!

Office management

Always keep the overview in day-to-day business

HERMA labels ensure the office is perfectly organized. They are used to identify files, shelves, folders etc. with colour codes. That means: quicker to find and less to search for.

Labels for files and data carriers or for addressing and shipping come in many designs and sizes, to suit every use and every occasion.



File spine labels

Perfect for all file spines. For affixing or inserting, white or coloured. Permanent or removable.

Page: 24 – 27



Removable labels

Residue-free removal without damaging the surfaces.

Page: 30 – 32



Coloured/Neon labels

Bring some colour into your office, colour identification facilitates organization of documents and samples.

Page: 34 – 35



Name/textile labels

Ideal for seminars, conferences and trade fairs. Reliable adhesion, easy to remove.

Page: 42 – 43



Transparent labels

Virtually invisible – perfect for professional, high-quality applications.

Page: 50



PREMIUM address labels

The first impression is crucial. With or without rounded corners.

Page: 20 – 23



For CDs and DVDs

Labelling, archiving and shipping – good and safe.

Page: 28 – 29

Addressing and shipping

For a professional look

Addressing and shipping has never been so easy, safe and convenient. HERMA labels offer a variety of formats, materials and functions for all standard letters, parcels and packages. Many label formats are suitable for accurate postage printouts directly using a PC.

Their high-quality appearance, in some cases with rounded corners, makes a positive first impression on the recipient.



PREMIUM address labels

The best of HERMA. High whiteness for perfect printing results.

Pages: 20 – 23



Repositionable address labels

They can be peeled off without leaving a trace.

Pages: 30 – 31



Recycled address labels

Excellent: Label material made of 100% recycled paper.

Page: 36



Weatherproof shipping labels:

Robust and hard-wearing – legible whatever the weather. UV and age-resistant.

Page: 46



Shipping labels

Time-saving: Print shipping labels and bills of lading, invoices or advance shipping notices in a single print run.

Page: 37



Transparent address labels

are virtually invisible – perfect for professional, high-quality mailing.

Page: 50



Labels for shipping or warning notes

For individualized design to print out yourself.

Page: 53

Pricing and product identification

Excellent labelling

A large variety of design options plus optimally adapted adhesion to any surface: HERMA labels offer a vast range for pricing and product identification. For handwritten or printed labels, removable or with extremely strong adhesion, colour or black-and-white.

They stand equally for clarity, dependability and a professional look.



Removable price labels

Reliable adhesion on a wide range of surfaces. Even for fragile surfaces.

Pages: 30 – 32



Jewellery labels,

Ideal for labelling rings, watches, jewellery or glasses.

Page: 52



QR code labels

Ideal for mobile tagging of URLs, telephone numbers or addresses.

Page: 52



Robust tags

Non-adhesive, with perforation. For attachment with a tagging gun or with strings and bars.

Page: 54



Special forms

Ideal for labels that have to stand out. For special prices or special offers.

Page: 32



Coloured/Neon labels

Eye-catching. Maximum impact for promotion campaigns, products and special offers.

Pages: 34 – 35

Production and logistics

When reliability counts

In production and logistics, labels are indispensable carriers of important information. They control the internal flow of materials and sometimes entire packaging lines via barcodes and QR codes. They have to adhere firmly – even at extreme temperatures, on sea or in dusty conditions.

This is why HERMA labels are used when the going gets tough – even at temperatures of minus 40°C or as hot as 150°. Or when chemicals, oil and dirt are involved.



Weatherproof shipping labels

Robust and hard-wearing – legible whatever the weather. UV and ageing-resistant.

Page: 46



Coloured/Neon labels

Striking colours ensure maximum attention. In 4 striking colours.

Pages: 34 – 35



Weatherproof film labels, removable

Ideal for temporary product labelling outdoors.

Page: 47



Power labels

Paper labels with extra strong adhesion: the right choice for very difficult adhesion conditions.

Page: 33



Weatherproof film labels, yellow

High-visibility thanks to yellow signalling colour.

Page: 46



Rating plates

Label inventory and components permanently and dependably.

Page: 48



Tags

Robust and easy to attach. For marking of material flows, pipes, wire, profiled sections, coils or spools.

Page: 54

Outdoor applications

When the going gets tough

Long-lasting labelling even in unusual conditions – that's where HERMA labels are increasingly the first choice for users. For difficult surfaces or harsh environments, in windy, hot or cold weather – HERMA supplies the optimum label for every purpose.

Yet they can be printed out very easily, quickly and as needed using a PC and printer.



Outdoor film labels

Extremely strong adhesion, even under extreme conditions.

Page: 45



Weatherproof film labels, yellow

High visibility thanks to yellow signalling colour.

Page: 46



Weatherproof film labels

Weatherproof, UV and age-resistant.

Pages: 46 – 47



Weatherproof film labels, removable

Ideal for temporary product labelling outdoors.

Page: 47



Transparent labels, matt or crystal-clear

Virtually invisible once applied.

Page: 50



Weather-resistant labels

Impregnated special paper with extremely strong adhesion, even on critical surfaces.

Page: 44



Rating plates

Smart stainless steel look. Resistant to weather and ageing.

Page: 48

Decorative identification

Brilliant prints guaranteed

Crystal-clear or glossy, in silver or any other eye-catching colour: the decorative labels from HERMA really grab your attention, as anniversary and celebration labels or as sender labels on high-quality presentation folders.

With their no-label look, transparent labels are ideal for high-quality labelling on paper, glass, plastic and metal.



Labels in silver film

High-quality labels with glossy look.

Page: 51



Transparent labels, matt or crystal clear

Virtually invisible once applied.

Page: 50



High-gloss labels

Top colour prints in photo quality. For laser or inkjet printers.

Pages: 39, 41



Bottle labels

Ideal for individualized gifts.

Page: 39



Coloured/Neon labels

Better organization and clarity thanks to coloured labels.

Pages: 34 – 35



Heart shaped labels

For special occasions such as weddings, as a loving greeting message or as a heartfelt packaging closure.

Page: 23

Well-thought-out solutions for every application

Product solutions for every application: with materials and adhesives that are perfectly adjusted to the task – no wish remains open.

Adhesive strength	Material	Colour	Indoor	Outdoor	Printer suitability			Guide system	Product	Details starting on page
					Laser printer	Copiers	Inkjet-printer			
permanent	Paper, FSC™-certified	white	●		●	●	●	■	PREMIUM general use and address labels	20
	Labels made of recycled paper, Blue Angel	natural white	●		●	●	●	■	Label material from recycled paper	36
	Silphie paper, FSC™-certified	natural brown	●		●	●	●	■	Labels made of silphie paper	37
	Paper, colour, FSC™-certified	yellow, red, blue, green	●		●	●	●	■	Coloured labels	34
	Paper, luminous colours FSC™-certified	luminous yellow, orange, red, green	●		●	●		■	Neon labels	35
	Paper, opaque	white, opaque	●		●	●	●	■	File spine labels, permanent	24
	Paper, colour, FSC™-certified	yellow, red, blue, green	●		●	●	●	■	File spine labels, permanent	24
	Paper, FSC™-certified	white	●		●	●	●	■	CD, video, slide and diskette labels	28
	Paper, opaque, FSC™-certified	white, opaque	●		●	●	●	■	Correction/covering labels, QR code labels	52
	High-gloss paper, FSC™-certified	white, glossy	●		●	●		■	Glossy labels for laser printers	41
	Paper (inkjet)	white, matt, coated	●				●	■	Inkjet labels, photo quality	38
	High-gloss paper (inkjet)	white, high-gloss, opaque, coated	●				●	■	Glossy labels for inkjet printers	39
	Special film (inkjet)	transparent, glossy, coated	●				●	■	Film labels for inkjet printers, transparent	39
	Special film (inkjet)	white, matt, opaque, coated	●	●			●	■	Weather-proof film labels for inkjet printers	39
	Foil	silver, glossy	●	●		●	●	■	Foil labels, silver	51
removable without residue, adhere again several times	Paper, FSC™-certified	white	●		●	●	●	■	Removable/repositionable labels	30
	Paper, FSC™-certified	white	●		●	●	●	■	Repositionable address labels	30
	Paper, FSC™-certified	white, opaque	●		●	●	●	■	Repositionable opaque address labels	30
	Paper, FSC™-certified	white, opaque	●		●	●	●	■	Removable file spine labels	26
	Paper, FSC™-certified	white	●		●	●	●	■	Price labels	30
removable without residue	Film (PE)	white, matt	●	●	●	●		■	Weatherproof film labels, removable	47
extremely strong adhesion, even on critical surfaces	Paper, FSC™-certified	white	●		●	●	●	■	Power labels	33
	Impregnated special paper	white	●	●	●	●		■	Weather-resistant labels	44
	Film (PE)	white, matt	●	●	●	●		■	Outdoor film labels	45
	Film (PET)	white, matt	●	●	●	●		■	Weather-resistant film labels	46
	Film (PET)	yellow, matt	●	●	●	●		■	Weather-resistant film labels, yellow	46
	Film (PET)	transparent, matt	●	●	●	●		■	Transparent film labels, matt	50
	Film (PET)	transparent, crystal-clear, high-gloss	●	●	●	●		■	Crystal-clear labels	50
	Film (PET)	silver, matt	●	●	●	●		■	Rating plates	48
	Film (PET)	transparent, matt	●	●	●	●		■	Seal labels	49
high adhesive, tamper-proof	Film (PET)	white, matt	●		●	●		■	Security labels	49
removable on textiles	Acetate silk	white	●		●	●		■	Name labels, textile labels	42
suitable for deepfreeze (down to -60°C)	Paper, FSC™-certified	white	●		●	●	●	■	Deep-freeze labels	53
non-adhesive, perforated	Card, FSC™-certified	white, satin finish	●		●	●	●	■	Spine insert labels	43
	Card, FSC™-certified	white, satin finish	●		●	●	●	■	CD and DVD inlay cards	43
	Card, FSC™-certified	white, satin finish	●		●	●	●	■	Inserts for name badges	43
	Paper/film/paper	white, tear-proof	●		●	●	●	■	Price tags	54

Looking for a particular label format? You've come to the right place.

The labels are sorted by format in increasing order of size.

The available versions are shown below the format and the product details can be found on the page indicated.

17.8 x 10.0 mm Removable 30	24.0 x 24.0 mm Removable 32 Resistant 46	25.4 x 10.0 mm PREMIUM 20 Removable 30 Strong adhes. 33 Coloured 34 Recycling 36 Silphie paper 37 Rating plate 48	25.4 x 16.9 mm PREMIUM 20 Removable 30 Strong adhes. 33	25.4 x 8.5 mm Inkjet 38	25.4 x 25.4 mm Removable 32 Inkjet 38	30.5 x 16.9 mm Inkjet 38 Silver foil 51	35.6 x 16.9 mm PREMIUM 20 Removable 30 Strong adhes. 33 Recycling 36 Silphie paper 37
35.6 x 16.9 mm Pricing 32	37.0 x 13.0 mm Strong adhes. 33 Resistant 46	37.0 x 25.0 mm Resistant 46	38.1 x 12.7 mm Removable 30	38.1 x 21.2 mm PREMIUM 20 Removable 30 Strong adhes. 33 Recycling 36 Deep-freeze 53 Inkjet 38	38.1 x 21.2 mm PREMIUM 20	40.0 x 40.0 mm Removable 32 Resistant 46 QR code 52	43.2 x 8.5 mm Slide 29
45.7 x 16.9 mm Tab 30 Removable 30	45.7 x 21.2 mm Removable 30 Strong adhes. 33 Coloured 34 Inkjet 38 Outdoor 45 Yellow foil 46 Rating plate 48 Security 49 Transparent 50 Crystal clear 50 Silver foil 51	48.3 x 16.9 mm PREMIUM 20 Opaque 52	48.3 x 25.4 mm PREMIUM 20 Strong adhes. 33 Recycling 36 Resistant 46 Weather-pr. rem. 47 Transparent 50	48.3 x 33.8 mm PREMIUM 20 Silphie paper 37	48.5 x 25.4 mm PREMIUM 20	50.0 x 142.0 mm Warning 53	52.5 x 21.2 mm PREMIUM 20 Removable 30
52.5 x 29.7 mm PREMIUM 20 Transparent 30	59.0 x 50.0 mm ZIP diskettes 29	60.0 x 60.0 mm Removable 32	63.5 x 8.5 mm Data Cartridge 29 Removable 30	63.5 x 16.9 mm Removable 30	63.5 x 25.4 mm Inkjet 38	63.5 x 29.6 mm Removable 30 Strong adhes. 33 Neon 35 Ink/weather-pr. 39 Name label 42 Yellow foil 46 Rating plate 48 Security 49 Silver foil 51	63.5 x 33.9 mm PREMIUM 20 Outdoor 45

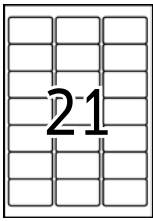

63.5 x 38.1 mm
 PREMIUM 20
 Removable 30
 Address/Rem. 30
 Recycling 36
 Address/Recy. 36
 Inkjet 38
 Address/Inkjet 38
 Glossy Laser 41
 Address/transp. 50
 Transparent 50
 Crystal clear 50
 Silver foil 51
 5 Sheets 54

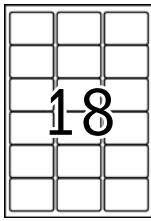

63.5 x 46.6 mm
 PREMIUM 20
 Removable 30

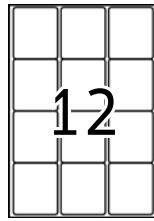

63.5 x 72.0 mm
 PREMIUM 20

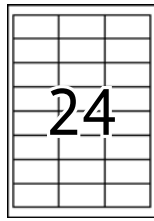

64.6 x 33.8 mm
 PREMIUM 20
 Opaque 52

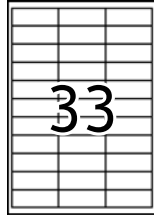

66.0 x 25.4 mm
 PREMIUM 20



66.0 x 33.8 mm
 PREMIUM 20
 Deep-freeze 53
 Inkjet 38
 Resistant 46
 Weather-pr. rem.. 47
 Transparent 50
 Address/transp. 50

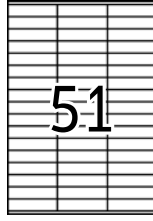

70.0 x 16.9 mm
 PREMIUM 20

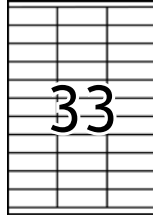

70.0 x 25.4 mm
 PREMIUM 20

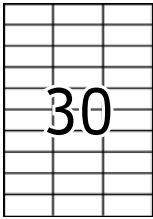

70.0 x 29.7 mm
 PREMIUM 20

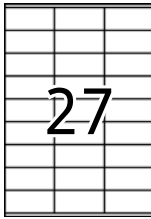

70.0 x 32.0 mm
 PREMIUM 20

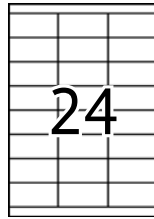

70.0 x 33.8 mm
 PREMIUM 20

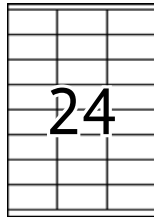

70.0 x 35.0 mm
 PREMIUM 20

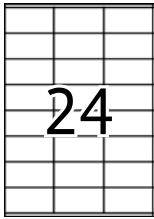

70.0 x 36.0 mm
 PREMIUM 20
 Strong adhes. 33
 Recycling 36
 Silphie paper 37



70.0 x 37.0 mm
 PREMIUM 20
 Coloured 34
 Recycling 36
 Resistant 46
 Transparent 50
 Address/transp. 50

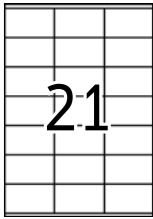

70.0 x 41.0 mm
 PREMIUM 20

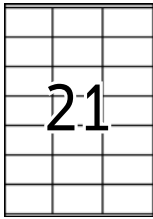

70.0 x 42.0 mm
 PREMIUM 20

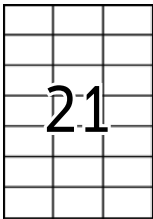

70.0 x 42.3 mm
 PREMIUM 20
 Strong adhes. 33

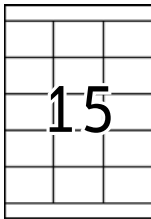

70.0 x 50.8 mm
 PREMIUM 22

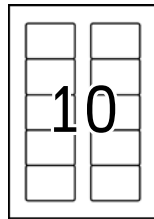

70.0 x 50.8 mm
 Diskettes 29

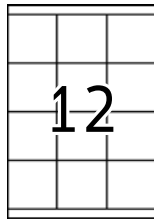

70.0 x 67.7 mm
 PREMIUM 22

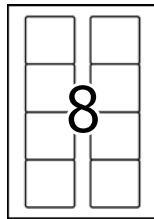

70.0 x 67.7 mm
 Diskettes 29

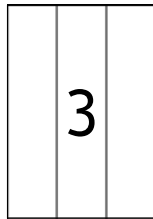

70.0 x 297.0 mm
 PREMIUM 22

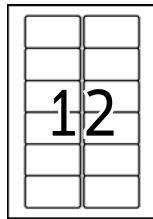

78.7 x 46.6 mm
 Video 29

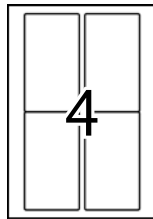

78.7 x 139.7 mm
 PREMIUM 22

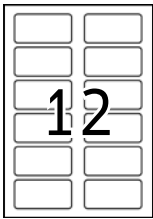

80.0 x 40.0 mm
 QR code 52

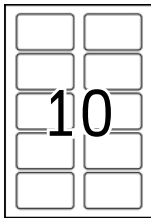

80.0 x 50.0 mm
 Name label 42

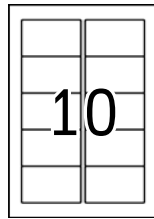

83.8 x 50.8 mm
 PREMIUM 22
 Inkjet 38

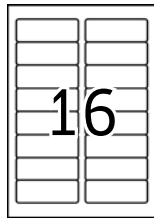

88.9 x 33.8 mm
 PREMIUM 20
 Removable 30
 Name label 42

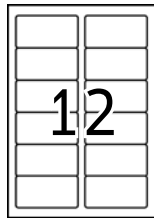

88.9 x 46.6 mm
 PREMIUM 20
 Removable 30
 Inkjet 38
 Address/Inkjet 38
 Glossy Laser 41

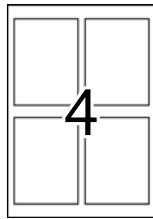

90.0 x 120.0 mm
 Bottle label 39



96,0 x 10,0 mm
 Removable 30

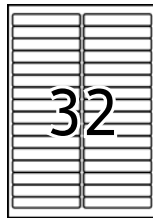

96,0 x 16,9 mm
 Removable 30

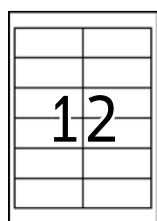

96.0 x 42.3 mm
Removable 30

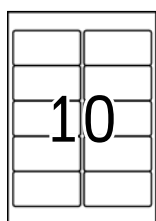

96.0 x 50.8 mm
PREMIUM 22
Address/Rem. 30
Removable 30
Rating plate 48
Crystal clear 50
Silver foil 51

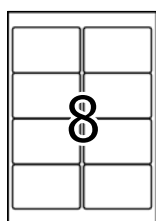

96,0 x 63,5 mm
Removable 30
Glossy Laser 41

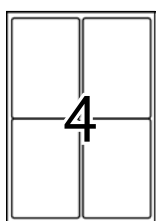

96,0 x 139,7 mm
Address/Inkjet 38
Inkjet 38
Glossy Laser 41

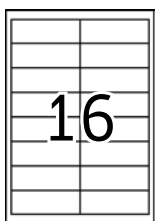

97.0 x 33.8 mm
PREMIUM 22
Address/Inkjet 38
Inkjet 38

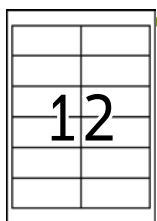

97.0 x 42.3 mm
PREMIUM 22
Strong adhes. 33
Silphie paper 37
Inkjet 38
Address/Inkjet 38
Ink/weather-pr. 39
Resistant 46
Weather-pr. rem.. 47
Transparent 50
Address/transp. 50
Opaque 52

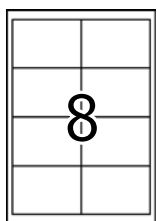

97.0 x 67.7 mm
PREMIUM 22

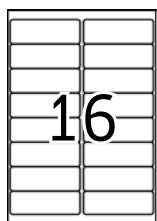

99.1 x 33.8 mm
PREMIUM 22
Removable 30
Address/Rem. 30
Address/Recy. 36
Recycling 36

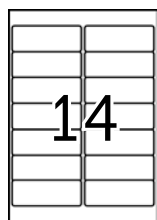

99.1 x 38.1 mm
PREMIUM 22
Removable 30
Address/Rem. 30
Address/Recy. 36
Recycling 36
Transparent 50
Address/transp. 50

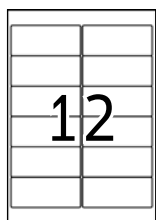

99.1 x 42.3 mm
Address/Rem. 30
Removable 30
Outdoor 45
Yellow foil 46

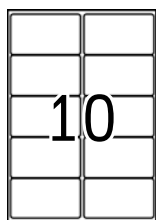

99.1 x 57.0 mm
PREMIUM 22
Removable 30
Address/Rem. 30
Address/weather. 46
Resistant 46

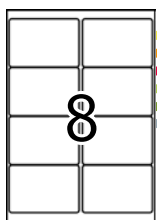

99.1 x 67.7 mm
PREMIUM 22
Removable 30
Address/Rem. 30
Neon 35
Recycling 36
Silphie paper 37
Warning 53
Address/weather. 46
Resistant 46
Weather-pr. rem.. 47
Silver foil 51

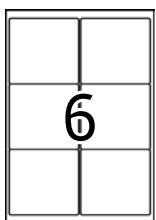

99.1 x 93.1 mm
PREMIUM 22
Removable 30
Address/Rem. 30
Address/weather. 46
Resistant 46

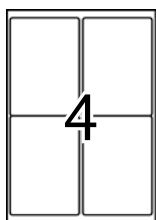

99.1 x 139.0 mm
PREMIUM 22
Address/Rem. 30
Removable 30
Outdoor 45
Crystal clear 50
5 Sheets 54

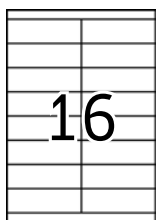

105.0 x 33.8 mm
PREMIUM 22

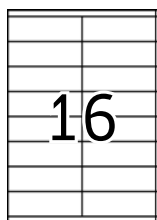

105.0 x 35.0 mm
PREMIUM 22

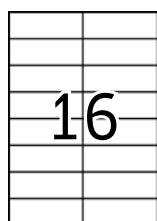

105.0 x 37.0 mm
PREMIUM 22
Coloured 34

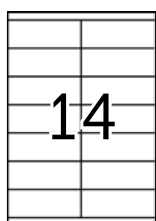

105.0 x 39.0 mm
PREMIUM 22

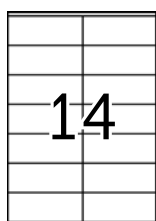

105.0 x 41.0 mm
PREMIUM 22

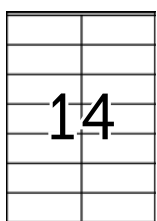

105.0 x 42.0 mm
PREMIUM 22

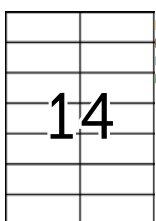

105.0 x 42.3 mm
PREMIUM 22
Removable 31
Coloured 34

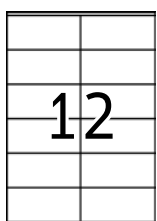

105.0 x 48.0 mm
PREMIUM 22
Strong adhes. 33
Recycling 36

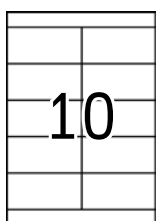

105.0 x 50.8 mm
PREMIUM 22

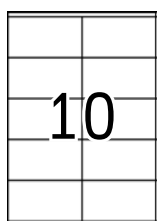

105.0 x 57.0 mm
PREMIUM 22

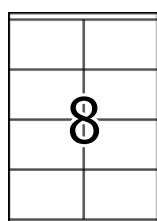

105.0 x 70.0 mm
PREMIUM 22

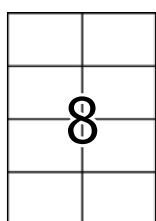

105.0 x 74.0 mm
PREMIUM 22

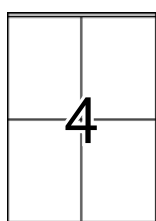

105.0 x 144.0 mm
PREMIUM 22



105.0 x 148.0 mm
PREMIUM 23
Removable 31
Strong adhes. 33
Coloured 34
Recycling 36
Silphie paper 37
Ink/weather-pr. 39
Impregnated 44
Resistant 46
Yellow foil 46
Weather-pr. rem.. 47
Rating plate 48
Opaque 52

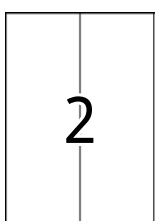

105.0 x 297.0 mm
PREMIUM 23

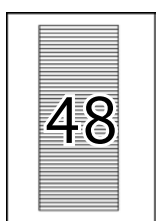

114.3 x 5.5 mm
CD box (spine) 28

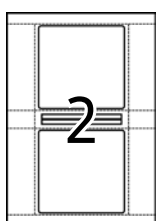

121.5 x 117.5 mm
CD cover 28

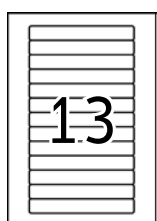

147.3 x 20.0 mm
Video 29

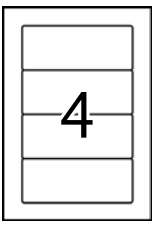

157.0 x 61.0 mm
File A5 25

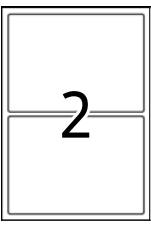

190.0 x 135.0 mm
Resistant 46

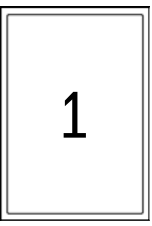

190.0 x 275.0 mm
Resistant 46



192.0 x 10.0 mm
Removable 31

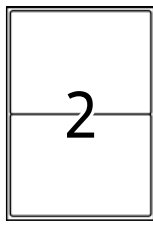

199.6 x 143.5 mm
PREMIUM 23
Removable 31
Coloured 34
Recycling 36
Glossy Laser 41
Textile labels 42

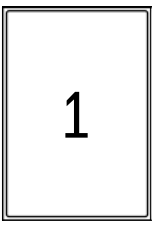

199.6 x 289.1 mm
PREMIUM 23
Recycling 36

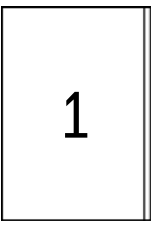

200.0 x 297.0 mm
PREMIUM 23

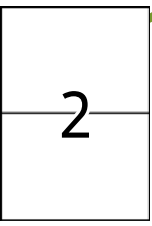

210.0 x 148.0 mm
PREMIUM 23
Strong adhes. 33
Recycling 36
Silphie paper 37
Ink/weather-pr. 39
Impregnated 44
Outdoor 45
Resistant 46
Address/transp. 50
Transparent 50



210.0 x 297.0 mm
PREMIUM 23
Removable 31
Strong adhes. 33
Coloured 34
Neon 35
Recycling 36
Silphie paper 37

Inkjet 38
Resistant 46
Ink/weather-pr. 39
Weather-pr. rem. 47
Glossy Ink 39
Rating plate 48
Glossy Laser 41
Transparent 50
Impregnated 44
Crystal clear 50
Outdoor 45
Silver foil 51
Yellow foil 46
Opaque 52

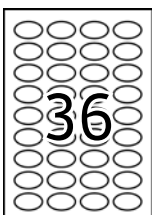

40.6 x 25.4 mm
Removable 32

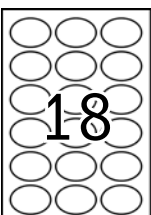

58.4 x 42.3 mm
Silver foil 51

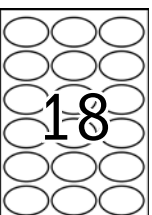

63.5 x 42.3 mm
Removable 32

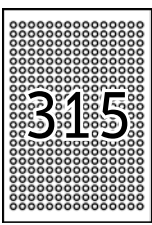

ø 10 mm
Removable 32

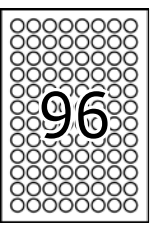

ø 20 mm
Removable 32

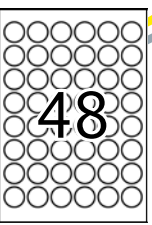

ø 30 mm
Removable 32
Strong adhes. 33
Yellow foil 46
Weather-pr. rem. 47
Rating plate 48

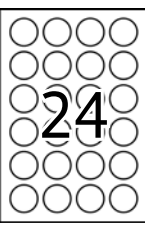

ø 40 mm
Removable 32
Security 49
Seal 49
Transparent 50
Crystal clear 50

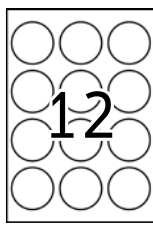

ø 60 mm
Removable 32
Neon 35

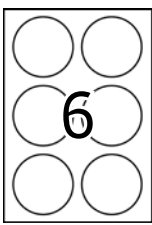

ø 85 mm
Removable 32
Resistant 46
Yellow foil 46



ø 35 mm
PREMIUM 23



ø 60 mm
PREMIUM 23

File spine labels

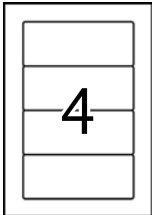

157.0 x 61.0 mm
Permanent 25



192.0 x 16.9 mm
Permanent 24

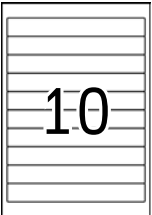

192.0 x 25.4 mm
Permanent 24



192.0 x 34.0 mm
Permanent 24
Removable 26

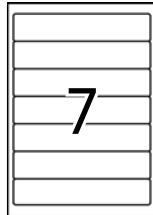

192.0 x 38.0 mm
Permanent 24
Coloured 25
Removable 26
Inkjet 27
Recycling 36
Silphie paper 37
5 Sheets 56



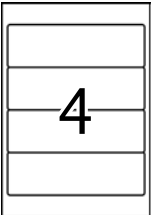

192.0 x 59.0 mm
Permanent 24
Removable 26



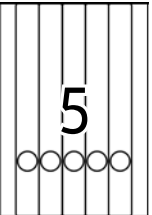

192.0 x 61.0 mm
Permanent 24
Coloured 25
Recycling 36
Silphie paper 37
Inkjet 27
Recycling 27
5 Sheets 56

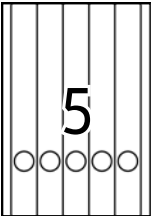
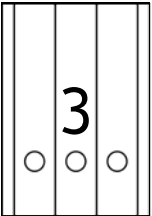
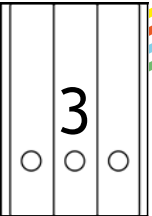
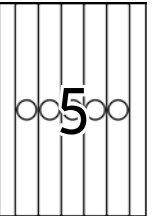
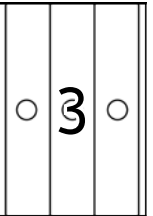
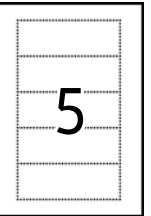
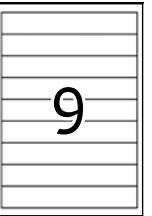



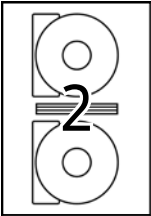
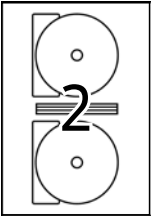
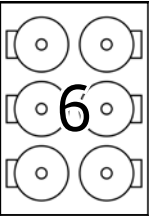

34.0 x 297.0 mm
Permanent 25

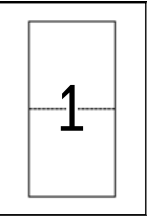
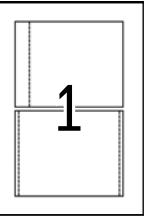
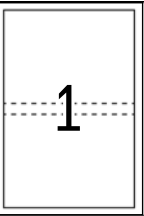
							
38.0 x 297.0 mm	59.0 x 297.0 mm	61.0 x 297.0 mm	34.0 x 297.0 mm	63.0 x 297.0 mm	146.0 x 50.0 mm	190.0 x 30.0 mm	190.0 x 54.0 mm
Permanent 25	Permanent 25	Permanent 25	Permanent 25	Permanent 25	Spine insert label 43	Spine insert label 43	Spine insert label 43
Coloured 25	Removable 26	Coloured 25					
Removable 26		Removable 26					
Inkjet 27		Inkjet 27					

CD labels and inlays

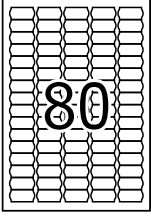
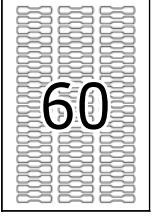
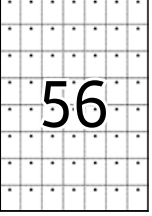
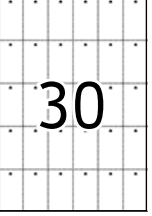
						
∅ 116 mm	∅ 116 mm Maxi	∅ 78 mm	114,3 x 5,5 mm	121.0 x 242.0 mm	151.0 x 118.0 mm	183.0 x 273.0 mm
Opaque 28	Opaque 28	Mini-CD 8 cm 28	CD box (spine) 28	CD inlay Slimcase 29	CD inlay Jewelcase 29	DVD inlay 29
Inkjet 28	Inkjet 28					
Glossy Inkjet 28	Glossy Inkjet 28					
	Glossy Laser 28					



Special applications

							
35.6 x 16.9 mm	49.0 x 10.0 mm	30.0 x 37.0 mm	35.0 x 59.4 mm	42.0 x 70.0 mm	52.5 x 93.5 mm	70.0 x 148.5 mm	182.0 x 130.0 mm
Pricing 32	Jewellery label 52	Tag 54	Tag 54	Tag 54	Tag 54	Tag 54	Shipping labels. 53 + note

Special applications

Inserts for name badges

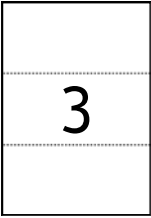
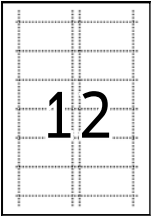
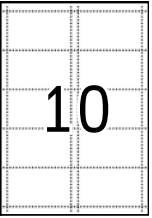
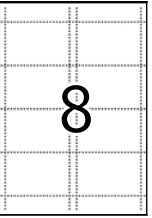
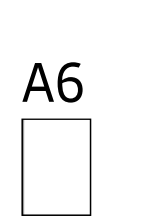
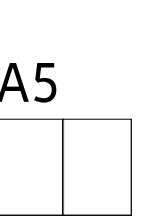
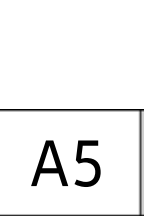
Sheet format A6, A5 und A3

							
210.0 x 99.0 mm	75.0 x 40.0 mm	90.0 x 54.0 mm	90.0 x 60.0 mm	105.0 x 148.0 mm	148.5 x 105.0 mm	148.5 x 205.0 mm	420.0 x 297.0 mm
Perforated 54	Perforated 43	Perforated 43	Perforated 43	PREMIUM 23	PREMIUM 23	PREMIUM 23	PREMIUM 23
							Outdoor 45
							Crystal clear 50

PREMIUM labels for general use and addressing

Absolutely reliable. top-quality printing results. firmly adhesive.

HERMA PREMIUM sets technology and quality standards. The extra-strong bonding to liner makes the labels suitable for high-speed printing, while optimum flatness prevents jamming whatever the PC printer or copier. The extremely high-white paper produces brilliant, sharp printouts.

- Perceptibly thicker: extra-strong labels – easy to affix
- Very fast, reliable adhesion, now even on cool, moist surfaces
- Kind to the environment and sustainable: FSC™-certified label material, chlorine-free bleached, acid and solvent-free
- 100% recyclable, dispose of as for waste paper



Tried and tested

Certified by TÜV SÜD.
HERMA PREMIUM labels guarantee trouble-free printing on laser and inkjet printers.

PREMIUM labels for general use and addressing

Paper, permanent adhesion		10 Sheets		25 Sheets		100 Sheets		200 Sheets		Printer compatibility					
Label format (mm)	Description	Features	Labels/ sheet	Labels/ pack.	Ref. no.	Labels/ pack.	Ref. no.	Labels/ pack.	Ref. no.	Labels/ pack.	Ref. no.	Laser	Copy	Ink	Colour laser
25.4 x 10.0	white	☐ F	189			4725	4333					✓	✓	✓	✓
25.4 x 16.9	white	☐ F	112			2800	4334					✓	✓	✓	✓
35.6 x 16.9	white	☐ F	80			2000	4336					✓	✓	✓	✓
38.1 x 21.2	white	☐ F	65	650	8629	1625	5027	6500	4270	13000	4606	✓	✓	✓	✓
38.1 x 21.2	white, ideal for sender address label	☐ F	65			1625	4504	6500	4254			✓	✓	✓	✓
48.3 x 16.9	white	☐ F	64					6400	4271	12800	4607	✓	✓	✓	✓
48.3 x 25.4	white	☐ F	44			1100	5051	4400	4272	8800	4608	✓	✓	✓	✓
48.3 x 33.8	white ^{1,2)}	☐ F	32	320	8643	800	4200					✓	✓	✓	✓
48.5 x 25.4	white	☐ F	40			1000	4357	4000	4474			✓	✓	✓	✓
52.5 x 21.2	white	F	56			1400	5052	5600	4273	11200	4609	✓	✓	✓	✓
52.5 x 29.7	white	F	40					4000	4461	8000	4610	✓	✓	✓	✓
63.5 x 33.9	white, ideal for C6 envelope	☐ F	24			600	4500	2400	4645			✓	✓	✓	✓
63.5 x 38.1	white, ideal for C6 envelope	☐ F	21	210	8632	525	5029	2100	4677			✓	✓	✓	✓
63.5 x 46.6	white, ideal for C6 envelope	☐ F	18			450	4501	1800	4265			✓	✓	✓	✓
63.5 x 72.0	white	☐ F	12					1200	4266			✓	✓	✓	✓
64.6 x 33.8	white ^{1,1)}	☐ F	24					2400	4262	4800	4632	✓	✓	✓	✓
66.0 x 25.4	white	☐ F	33					3300	4275	6600	4613	✓	✓	✓	✓
66.0 x 33.8	white ^{1,1)}	☐ F	24	240	8633	600	5053	2400	4670	4800	4614	✓	✓	✓	✓
70.0 x 16.9	white	F	51					5100	4459	10200	4611	✓	✓	✓	✓
70.0 x 25.4	white	F	33					3300	4455			✓	✓	✓	✓
70.0 x 29.7	white	F	30					3000	4456	6000	4612	✓	✓	✓	✓
70.0 x 32.0	white	F	27					2700	4450			✓	✓	✓	✓
70.0 x 33.8	white	F	24					2400	4263			✓	✓	✓	✓
70.0 x 35.0	white	F	24					2400	4429			✓	✓	✓	✓
70.0 x 36.0*	white ^{1,1)}	F	24	240	8638	600	4360	2400	4453	4800	4633	✓	✓	✓	✓
70.0 x 37.0	white	F	24	240	8644	600	4390	2400	4464	4800	4615	✓	✓	✓	✓
70.0 x 41.0	white ^{1,1)}	F	21					2100	4473	4200	4634	✓	✓	✓	✓
70.0 x 42.0**	white ^{1,1)}	F	21			525	4361	2100	4451			✓	✓	✓	✓
70.0 x 42.3	white ^{1,1)}	F	21	210	8634	525	5054	2100	4668	4200	4616	✓	✓	✓	✓

* also in 500 sheets: Ref.no. 4414^{1,1)} ** also in 500 sheets: Ref.no. 4415^{1,1)}

Excellent!

With all HERMA PREMIUM labels, guaranteed no paper jams on all laser and inkjet printers!



Tried and tested

Certified by TÜV SÜD.
HERMA PREMIUM labels guarantee trouble-free printing on laser and inkjet printers. Guaranteed jam-free and high-speed capable due to extra strong special composite, top flatness and all-round protective edge.



PREMIUM labels for general use and addressing

PREMIUM labels for general use and addressing

25.4 x 10.0	25.4 x 16.9	35.6 x 16.9	38.1 x 21.2	38.1 x 21.2	48.3 x 16.9	48.3 x 25.4	48.3 x 33.8	48.5 x 25.4	52.5 x 21.2
52.5 x 29.7	63.5 x 33.9	63.5 x 38.1	63.5 x 46.6	63.5 x 72.0	64.6 x 33.8	66.0 x 25.4	66.0 x 33.8	70.0 x 16.9	70.0 x 25.4
70.0 x 29.7	70.0 x 32.0	70.0 x 33.8	70.0 x 35.0	70.0 x 36.0	70.0 x 37.0	70.0 x 41.0	70.0 x 42.0	70.0 x 42.3	

INTERNETMARKE www.internetmarke.de
Ein Produkt der Deutschen Post

HERMA and Deutsche Post DHL have perfectly coordinated labels and software solutions – accurate postage printouts guaranteed. The formats available for this service are indicated in the tables. Suitable for INTERNETMARKE®:

- 1) without recipient's address
 - 1.1) optimized for printing with motif
 - 1.2) optimized for printing without motif
- 2) with recipient's address

- Rounded corners
- Sheet with border on all sides
- FSC™-certified label material from responsibly managed forests

Suitable for INTERNETMARKE®:
 1) without recipient's address
 1.1) optimized for printing with motif
 1.2) optimized for printing without motif

PREMIUM labels for general use and addressing

**Friendly to the environment:
PREMIUM label material – FSC™-certified.**

HERMA PREMIUM labels are made from FSC™-certified label material – that is, exclusively from material from sustainably managed forests and chlorine-free bleach. But HERMA goes beyond that manner. Our adhesive materials are coated with solvent-free adhesives.

- Perceptibly thicker: extra-strong labels – easy to affix
- Very fast, reliable adhesion, now even on cool, moist surfaces
- Kind to the environment and sustainable: FSC™-certified label material, chlorine-free bleached, acid and solvent-free
- 100% recyclable, dispose of as for waste paper



Look for FSC™-certified products!

PREMIUM labels for general use and addressing

Paper, permanent adhesion		10 Sheets		25 Sheets		100 Sheets		200 Sheets		Printer compatibility				
Label format (mm)	Description	Features	Labels/ sheet	Labels/ pack.	Ref. no.	Labels/ pack.	Ref. no.	Labels/ pack.	Ref. no.	Laser	Copy	Ink	Colour laser	
70.0 x 50.8	<input type="checkbox"/> white	F	15			375	5055	1500	4278	3000	4618	✓	✓	✓
70.0 x 67.7	<input type="checkbox"/> white	F	12					1200	4279	2400	4617	✓	✓	✓
70.0 x 297.0	<input type="checkbox"/> white	F	3					300	4657			✓	✓	✓
78.7 x 139.7	<input type="checkbox"/> white, ideal for parcels ²⁾	F	4					400	4472			✓	✓	✓
83.8 x 50.8	<input type="checkbox"/> white, approx. business card size	F	10			250	5028					✓	✓	✓
88.9 x 33.8	<input type="checkbox"/> white, ideal for DL envelope	F	16					1600	4479			✓	✓	✓
88.9 x 46.6	<input type="checkbox"/> white, ideal for DL envelope	F	12					1200	4666			✓	✓	✓
96.0 x 50.8	<input type="checkbox"/> white, ideal for C4/C5 envelope ²⁾	F	10					1000	4667			✓	✓	✓
97.0 x 33.8	<input type="checkbox"/> white	F	16					1600	4672	3200	4619	✓	✓	✓
97.0 x 42.3	<input type="checkbox"/> white ²⁾	F	12	120	8628	300	5056	1200	4669	2400	4623	✓	✓	✓
97.0 x 67.7	<input type="checkbox"/> white ²⁾	F	8			200	4359	800	4280	1600	4624	✓	✓	✓
99.1 x 33.8	<input type="checkbox"/> white, ideal for DL envelope	F	16			400	5075	1600	4267			✓	✓	✓
99.1 x 38.1	<input type="checkbox"/> white, ideal for DL envelope	F	14	140	8635	350	5076	1400	4678			✓	✓	✓
99.1 x 57.0	<input type="checkbox"/> white, ideal for C4/C5 envelope ²⁾	F	10					1000	4268			✓	✓	✓
99.1 x 67.7	<input type="checkbox"/> white, ideal for B4/C4-envelope ²⁾	F	8			200	5077	800	4269			✓	✓	✓
99.1 x 93.1	<input type="checkbox"/> white, ideal for parcels ²⁾	F	6			150	4502	600	4653			✓	✓	✓
99.1 x 139.0	<input type="checkbox"/> white, ideal for parcels ²⁾	F	4			100	4503	400	4250			✓	✓	✓
105.0 x 33.8	<input type="checkbox"/> white	F	16					1600	4264			✓	✓	✓
105.0 x 35.0	<input type="checkbox"/> white	F	16					1600	4427			✓	✓	✓
105.0 x 37.0	<input type="checkbox"/> white	F	16					1600	4462	3200	4620	✓	✓	✓
105.0 x 39.0	<input type="checkbox"/> white	F	14					1400	4654			✓	✓	✓
105.0 x 41.0	<input type="checkbox"/> white ²⁾	F	14					1400	4475			✓	✓	✓
105.0 x 42.0*	<input type="checkbox"/> white ²⁾	F	14					1400	4452			✓	✓	✓
105.0 x 42.3	<input type="checkbox"/> white ²⁾	F	14			350	5057	1400	4674	2800	4625	✓	✓	✓
105.0 x 48.0**	<input type="checkbox"/> white ²⁾	F	12			300	4363	1200	4457	2400	4635	✓	✓	✓
105.0 x 50.8	<input type="checkbox"/> white ²⁾	F	10					1000	4281	2000	4629	✓	✓	✓
105.0 x 57.0	<input type="checkbox"/> white ²⁾	F	10					1000	4425			✓	✓	✓
105.0 x 70.0	<input type="checkbox"/> white ²⁾	F	8					800	4426			✓	✓	✓
105.0 x 74.0	<input type="checkbox"/> white ²⁾	F	8	80	8645	200	5062	800	4470	1600	4626	✓	✓	✓

* also in 500 sheets: Ref.no. 4416 ²⁾ ** also in 500 sheets: Ref.no. 4417 ²⁾

PREMIUM labels for general use and addressing

Paper, permanent adhesion

Label format (mm)	Description	Features	Labels/ sheet	10 Sheets		25 Sheets		100 Sheets		200 Sheets		Printer compatibility			
				Labels/ pack.	Ref. no.	Labels/ pack.	Ref. no.	Labels/ pack.	Ref. no.	Labels/ pack.	Ref. no.	Laser	Copy	Ink	Colour laser
105.0 x 144.0	<input type="checkbox"/> white ²⁾		F 4					400	4454			✓	✓	✓	✓
105.0 x 148.0	<input type="checkbox"/> white ²⁾		F 4	40	8630	100	5063	400	4676	800	4627	✓	✓	✓	✓
105.0 x 297.0	<input type="checkbox"/> white		F 2					200	4658			✓	✓	✓	✓
199.6 x 143.5	<input type="checkbox"/> white, ideal for parcels ²⁾	<input type="checkbox"/>	F 2					200	4249			✓	✓	✓	✓
199.6 x 289.1	<input type="checkbox"/> white, ideal for parcels	<input type="checkbox"/>	F 1					100	4252			✓	✓	✓	✓
200.0 x 297.0	<input type="checkbox"/> white		F 1					100	4458			✓	✓	✓	✓
210.0 x 148.0	<input type="checkbox"/> white ²⁾		F 2	20	8636	50	5064	200	4282	400	4628	✓	✓	✓	✓
210.0 x 297.0	<input type="checkbox"/> white ³⁾		F 1	10	8637	25	5065	100	4428	200	4631	✓	✓	✓	✓
Special shape labels															
∅ 35	<input type="checkbox"/> white, heart-shaped		F 35	350	10790							✓	✓	✓	✓
∅ 60	<input type="checkbox"/> white, heart-shaped ²⁾		F 12	120	10791							✓	✓	✓	✓
Sheet format A6															
105.0 x 148.0	<input type="checkbox"/> white, individually printable (800 sheets/pack)	<input type="checkbox"/>	F 1							800	8689	✓	✓	✓	✓
Sheet format A5															
148.5 x 105.0	<input type="checkbox"/> white, ideal for parcels (400 sheets/pack.) ²⁾		F 2							800	8691	✓	✓	✓	✓
148.5 x 205.0	<input type="checkbox"/> white, with peel-off aid, for parcels ²⁾ (400 sh./pack)		F 1							400	8690	✓	✓	✓	✓
Sheet format A3															
420.0 x 297.0	<input type="checkbox"/> white		F 1					100	8692			✓	✓	✓	✓

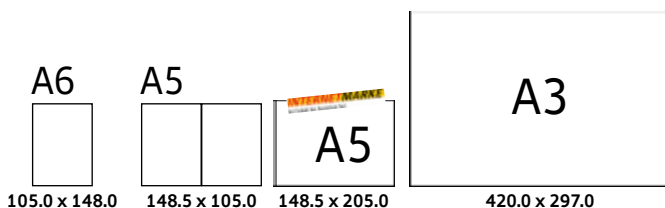
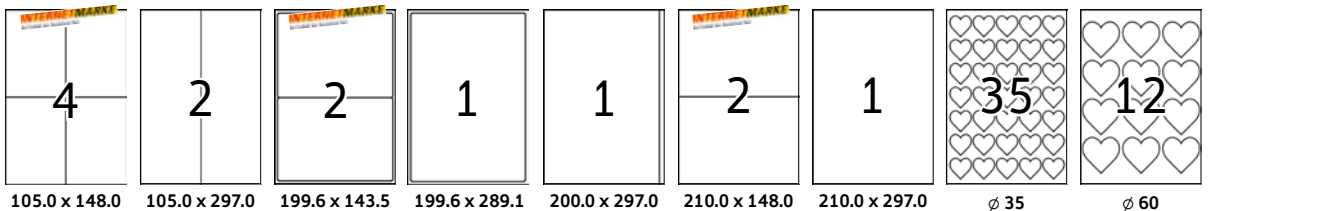
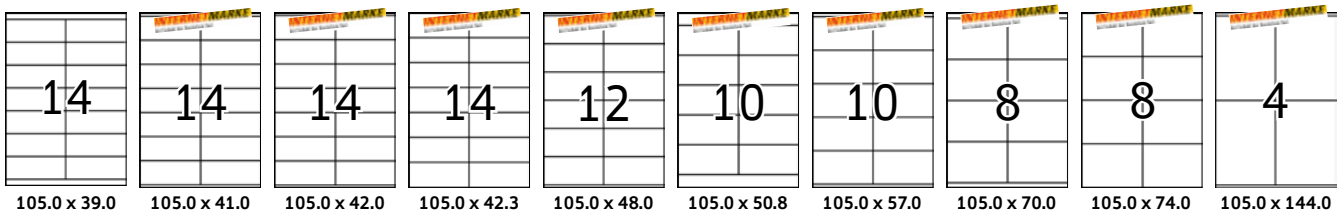
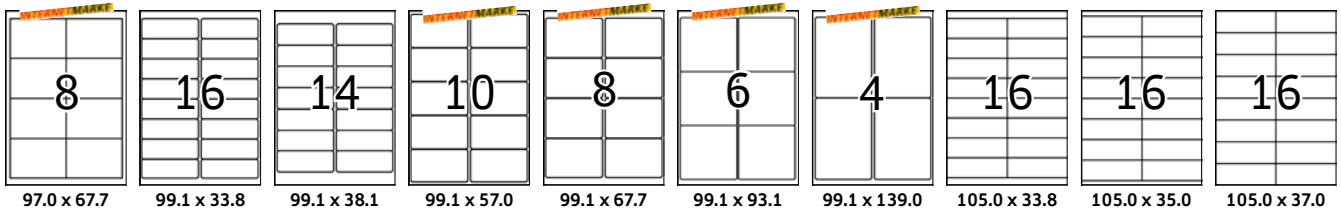
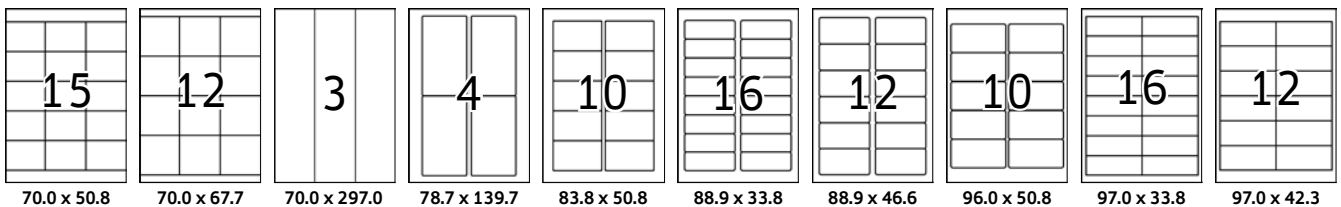

- Rounded corners
- Sheet with border on all sides
- F** FSC™-certified label material from responsibly managed forests
- ³⁾ Peel-off aid on reverse (4 cuts)

Suitable for INTERNETMARKE®:
²⁾ with recipient's address

File spine labels. permanent adhesion

Reliable adhesion. even with frequently used files.

No matter which kind of file you use, you'll find a HERMA label to fit your needs: for standing or hanging files, narrow or wide, short or long, or with a punched thumb hole. For affixing or inserting, white or coloured. Top-quality printing results in both black-and-white and colour guaranteed.

- Blank: ideal for company logos, inscriptions and organization notes
- White file spine labels are fully opaque, previous labels are masked completely
- Extra-narrow formats for spine widths of 25 mm or 37 mm
- Top-quality printing results in both black-and-white and colour guaranteed
- 100% recyclable, dispose of as for waste paper



File spine labels. permanent adhesion

Paper, permanent adhesion		10 Sheets		20/25 Sheets		100 Sheets		Printer compatibility					
Label format (mm)	Description	Features	Labels/ sheet	Labels/ pack.	Ref. no.	Labels/ pack.	Ref. no.	Labels/ pack.	Ref. no.	Laser	Copy	Ink	Colour laser
Ring binders, approx. 25 mm spine width													
192.0 x 16.9	white, narrow, short, opaque	☐ F	16			400	5118			✓	✓	✓	✓
Ring binders, approx. 37 mm spine width													
192.0 x 25.4	white, narrow, short, opaque	☐ F	10			250	5119			✓	✓	✓	✓
Elba, Biella, Mehle:													
192.0 x 34.0	white, narrow, short, opaque	☐ F	8			200	5160	800	4290	✓	✓	✓	✓
Leitz, Elba, Esselte, Mehle, Herlitz, Bene:													
192.0 x 38.0	white, narrow, short, opaque	☐ F	7	70	8620	175	5090	700	4283	✓	✓	✓	✓
	yellow, narrow, short	☐ F	7			140	5091			✓	✓	✓	✓
	red, narrow, short	☐ F	7			140	5092			✓	✓	✓	✓
	blue, narrow, short	☐ F	7			140	5093			✓	✓	✓	✓
	green, narrow, short	☐ F	7			140	5094			✓	✓	✓	✓
Elba, Esselte, Herlitz:													
192.0 x 59.0	white, wide, short, opaque	☐ F	4			100	5123	400	4291	✓	✓	✓	✓
Leitz, Elba, Mehle, Bene, Biella:													
192.0 x 61.0	white, wide, short, opaque	☐ F	4	40	8621	100	5095	400	4284	✓	✓	✓	✓
	yellow, wide, short	☐ F	4			80	5096	400	4296	✓	✓	✓	✓
	red, wide, short	☐ F	4			80	5097	400	4297	✓	✓	✓	✓
	blue, wide, short	☐ F	4			80	5098	400	4298	✓	✓	✓	✓
	green, wide, short	☐ F	4			80	5099	400	4299	✓	✓	✓	✓

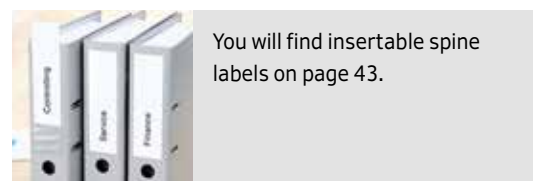
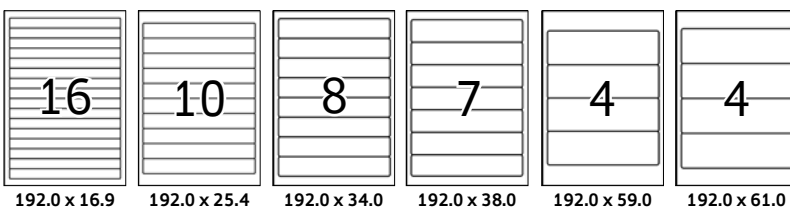

Design folder labels quickly and easily: Design templates in the Label Assistant Online.

- No software download, no installation
- Select format | Design label online | Print PDF locally
- Various design templates for folders, individually changeable
- Motifs for office, home & office and private themes
- Guided design with wizard for individual labels
- Tutorial videos for easy access and design

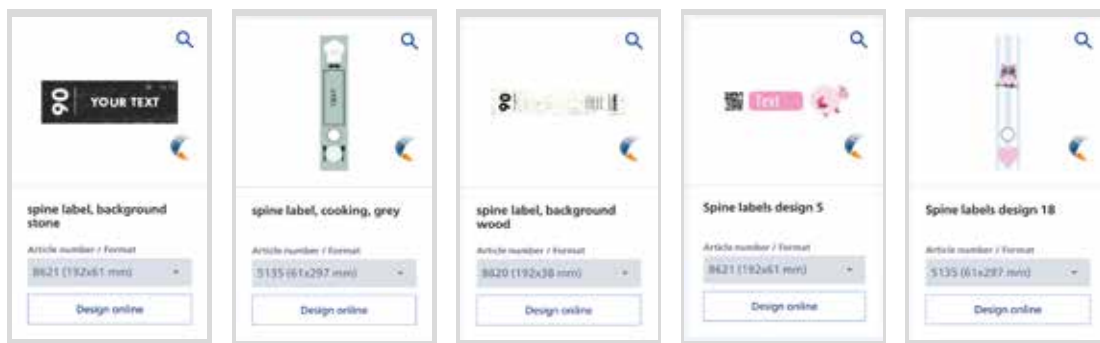

Discover the
HERMA Label
Assistant Online



www.herma.com/lao

File spine labels, permanent adhesion

File spine labels, permanent adhesion

Paper, permanent adhesion

Label format (mm)	Description	Features	Labels/ sheet	Labels/ pack.	Ref. no.	10 Sheets	20/25 Sheets	100 Sheets	Printer compatibility
									Laser Copy Ink Colour laser
Elba, Biella, Mehle:									
34.0 x 297.0	<input type="checkbox"/> white, narrow, long, thumb hole, opaque	⤵ F	5				125 5158		✓ ✓ ✓ ✓
Leitz, Elba, Esselte, Mehle, Herlitz, Bene:									
38.0 x 297.0	<input type="checkbox"/> white, narrow, long, thumb hole, opaque	⤵ F	5				125 5130		✓ ✓ ✓ ✓
	<input type="checkbox"/> yellow, narrow, long, thumb hole	⤵ F	5				100 5131		✓ ✓ ✓ ✓
	<input type="checkbox"/> red, narrow, long, thumb hole	⤵ F	5				100 5132		✓ ✓ ✓ ✓
	<input type="checkbox"/> blue, narrow, long, thumb hole	⤵ F	5				100 5133		✓ ✓ ✓ ✓
	<input type="checkbox"/> green, narrow, long, thumb hole	⤵ F	5				100 5134		✓ ✓ ✓ ✓
Elba, Esselte, Herlitz:									
59.0 x 297.0	<input type="checkbox"/> white, wide, long, thumb hole, opaque	⤵ F	3				75 5159		✓ ✓ ✓ ✓
Leitz, Elba, Mehle, Bene, Biella:									
61.0 x 297.0	<input type="checkbox"/> white, wide, long, thumb hole, opaque	⤵ F	3				75 5135		✓ ✓ ✓ ✓
	<input type="checkbox"/> yellow, wide, long, thumb hole	⤵ F	3				60 5136		✓ ✓ ✓ ✓
	<input type="checkbox"/> red, wide, long, thumb hole	⤵ F	3				60 5137		✓ ✓ ✓ ✓
	<input type="checkbox"/> blue, wide, long, thumb hole	⤵ F	3				60 5138		✓ ✓ ✓ ✓
	<input type="checkbox"/> green, wide, long, thumb hole	⤵ F	3				60 5139		✓ ✓ ✓ ✓
Leitz A5 files									
157.0 x 61.0	<input type="checkbox"/> white, wide, for A5 files, opaque	⤵ □ F	4				100 5121		✓ ✓ ✓ ✓
Leitz, Elba, Falken:									
34.0 x 297.0	<input type="checkbox"/> white, narrow, suspension files, opaque	⤵ F	5				125 5165		✓ ✓ ✓ ✓
Leitz, Elba:									
63.0 x 297.0	<input type="checkbox"/> white, wide, suspension files, opaque	⤵ F	3				75 5167		✓ ✓ ✓ ✓

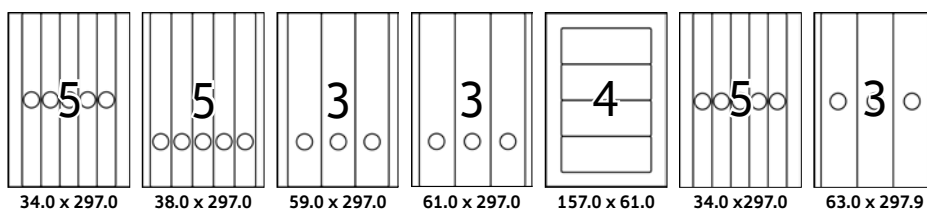

- ⤵ Rounded corners
- Sheet with border on all sides
- F FSC™-certified label material from responsibly managed forests

Removable file spine labels / File spine labels made of silphie paper

Wrong label position?

No problem thanks to removable adhesive.

Thanks to removable adhesive. The file spine labels can be removed without any problems. Labels that end up crooked are now a thing of the past.

The labels adhere firmly, even on files in frequent use.



Removable file spine labels

- Problem-free repositioning
- Residue-free removal without damaging the surface
- Fully opaque: nothing shines through
- 100% recyclable. dispose of as for waste paper

File spine labels made of silphie paper

- Grown in Germany, short transport routes, lower CO₂ emissions
- Modern kraft paper look, with at least 35 % silphie fibre content

Removable file spine labels

Paper, opaque, repositionable, removable without residue

Label format (mm)	Description	Features	Labels/ sheet	10 Sheets		25 Sheets		100 Sheets		Printer compatibility						
				Labels/ pack.	Ref. no.	Labels/ pack.	Ref. no.	Labels/ pack.	Ref. no.	Laser	Copy	Ink	Colour laser			
Elba, Biella, Mehle:																
192.0 x 34.0	<input type="checkbox"/> white, narrow, short, opaque	<input checked="" type="checkbox"/> <input type="checkbox"/> F	8			200	10150			<input checked="" type="checkbox"/>	<input checked="" type="checkbox"/>	<input checked="" type="checkbox"/>	<input checked="" type="checkbox"/>			
Leitz, Elba, Esselte, Mehle, Herlitz, Bene:																
192.0 x 38.0	<input type="checkbox"/> white, narrow, short, opaque	<input checked="" type="checkbox"/> <input type="checkbox"/> F	7			175	10155	700	10140	<input checked="" type="checkbox"/>	<input checked="" type="checkbox"/>	<input checked="" type="checkbox"/>	<input checked="" type="checkbox"/>			
Elba, Esselte, Herlitz:																
192.0 x 59.0	<input type="checkbox"/> white, wide, short, opaque	<input checked="" type="checkbox"/> <input type="checkbox"/> F	4			100	10160			<input checked="" type="checkbox"/>	<input checked="" type="checkbox"/>	<input checked="" type="checkbox"/>	<input checked="" type="checkbox"/>			
Leitz, Elba, Mehle, Bene, Biella:																
192.0 x 61.0	<input type="checkbox"/> white, wide, short, opaque	<input checked="" type="checkbox"/> <input type="checkbox"/> F	4			100	10165	400	10141	<input checked="" type="checkbox"/>	<input checked="" type="checkbox"/>	<input checked="" type="checkbox"/>	<input checked="" type="checkbox"/>			
Leitz, Elba, Esselte, Mehle, Herlitz, Bene:																
38.0 x 297.0	<input type="checkbox"/> white, narrow, long, thumb hole, opaque	<input checked="" type="checkbox"/> <input type="checkbox"/> F	5			125	10175			<input checked="" type="checkbox"/>	<input checked="" type="checkbox"/>	<input checked="" type="checkbox"/>	<input checked="" type="checkbox"/>			
Elba, Esselte, Herlitz:																
59.0 x 297.0	<input type="checkbox"/> white, wide, long, thumb hole, opaque	<input checked="" type="checkbox"/> <input type="checkbox"/> F	3			75	10180			<input checked="" type="checkbox"/>	<input checked="" type="checkbox"/>	<input checked="" type="checkbox"/>	<input checked="" type="checkbox"/>			
Leitz, Elba, Mehle, Bene, Biella:																
61.0 x 297.0	<input type="checkbox"/> white, wide, long, thumb hole, opaque	<input checked="" type="checkbox"/> <input type="checkbox"/> F	3			75	10185			<input checked="" type="checkbox"/>	<input checked="" type="checkbox"/>	<input checked="" type="checkbox"/>	<input checked="" type="checkbox"/>			

File spine labels made of silphie paper

Label material with at least 35 % silphie fibre content

Label format (mm)	Description	Features	Labels/ sheet	10 Sheets		20 Sheets		80 Sheets		Printer compatibility			
				Labels/ pack.	Ref. no.	Labels/ pack.	Ref. no.	Labels/ pack.	Ref. no.	Laser	Copy	Ink	Colour laser
192.0 x 38.0	<input type="checkbox"/> natural-brown, for narrow files	<input checked="" type="checkbox"/> <input type="checkbox"/> F	7			140	10759			<input checked="" type="checkbox"/>	<input checked="" type="checkbox"/>	<input checked="" type="checkbox"/>	<input checked="" type="checkbox"/>
192.0 x 61.0	<input type="checkbox"/> natural-brown, for wide files	<input checked="" type="checkbox"/> <input type="checkbox"/> F	4			80	10760			<input checked="" type="checkbox"/>	<input checked="" type="checkbox"/>	<input checked="" type="checkbox"/>	<input checked="" type="checkbox"/>

- Rounded corners
- Sheet with border on all sides
- F** FSC™-certified label material from responsibly managed forests

File spine labels made of recycled paper / Inkjet file spine labels

For more order in the filing cabinet.

Individually printed file labels not only look more professional. they also bring structure and organisation to your filing cabinet. Secure adhesion even with frequent use.



File spine labels made of recycled paper

- Label material made of 100% recycled paper
- High brightness and purity thanks to wastepaper selection. without the use of chlorine bleach or whitening agents (brightness ISO 97% / CIE 133)
- Smooth surface. high covering capacity



Inkjet file spine labels

- Specially designed for inkjet printers – special coated paper 90 g/m²
- Razor-sharp contours. brilliant colours

File spine labels made of recycled paper

Label material made of 100% recycled paper. permanent adhesion

Label format (mm)	Description	Features	Labels/ sheet	10 Sheets		25 Sheets		80 Sheets		Printer compatibility			
				Labels/ pack.	Ref. no.	Labels/ pack.	Ref. no.	Labels/ pack.	Ref. no.	Laser	Copy	Ink	Colour laser
Leitz. Elba. Esselte. Mehle. Herlitz. Bene:													
192.0 x 38.0	<input type="checkbox"/> white. narrow. short	┌ □ B	7					560	10834	✓	✓	✓	✓
Leitz. Elba. Mehle. Bene. Biella:													
192.0 x 61.0	<input type="checkbox"/> white. wide. short	┌ □ B	4					320	10835	✓	✓	✓	✓

Inkjet file spine labels

Special coated paper. quick-drying. photo quality. permanent adhesion

Label format (mm)	Description	Features	Labels/ sheet	10 Sheets		25 Sheets		100 Sheets		Printer compatibility			
				Labels/ pack.	Ref. no.	Labels/ pack.	Ref. no.	Labels/ pack.	Ref. no.	Laser	Copy	Ink	Colour laser
Leitz. Elba. Esselte. Mehle. Herlitz. Bene:													
192.0 x 38.0	<input type="checkbox"/> white. narrow. short	┌ □	7			175	4825						✓
Leitz. Elba. Mehle. Bene. Biella:													
192.0 x 61.0	<input type="checkbox"/> white. wide. short	┌ □	4			100	4826						✓
Leitz. Elba. Esselte. Mehle. Herlitz. Bene:													
38.0 x 297.0	<input type="checkbox"/> white. narrow. long. thumb hole	┌	5			125	4830						✓
Leitz. Elba. Mehle. Bene. Biella:													
61.0 x 297.0	<input type="checkbox"/> white. wide. long. thumb hole	┌	3			75	4831						✓

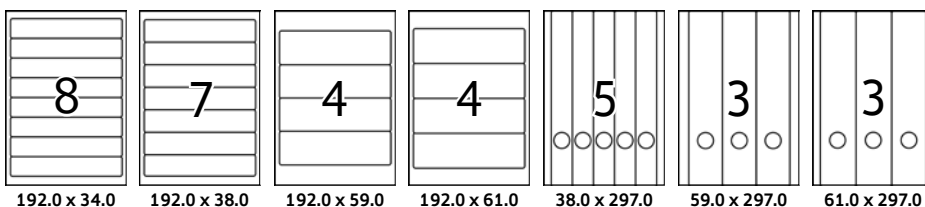

- ┌ Rounded corners
- Sheet with border on all sides
- B „Blue Angel“ certification

CD labels

Dead-centre placement – with no additional aids.

Each HERMA CD/DVD label has its own positioning aid. Just place the label in the jewel case and attach it. That's all. Your label is perfectly centred. The CD will run smoothly, even in high-speed drives. The positioning aid also keeps your fingers away from the adhesive – no problems with bothersome fingerprints.



CD labels

- High-white label material, fully opaque: printed surface of the CD does not shine through

Inkjet CD labels

- Photo-quality, dries instantly, wipe resistant
- Razor-sharp contours and brilliant colours

Free design templates:
www.herma.com/lao



CD labels

Paper, permanent adhesion		10 Sheets		25 Sheets		100 Sheets		Printer compatibility					
Label format (mm)	Description	Features	Labels/ sheet	Labels/ pack.	Ref. no.	Labels/ pack.	Ref. no.	Labels/ pack.	Ref. no.	Laser	Copy	Ink	Colour laser
∅ 116	<input type="checkbox"/> white, opaque, hole diameter : 41 mm	<input type="checkbox"/> F	2			50	5079	200	4471	✓	✓	✓	✓
∅ 116 Maxi	<input type="checkbox"/> white, opaque, hole diameter : 18.5 mm	<input type="checkbox"/> F	2	20	8624	50	5115	200	4460	✓	✓	✓	✓
∅ 78	<input type="checkbox"/> white, opaque, Mini-CD 8 cm, hole diameter : 18.5 mm	<input type="checkbox"/> F	6	60	8619					✓	✓	✓	✓
114.3 x 5.5	<input type="checkbox"/> white, CD Box	<input checked="" type="checkbox"/> F	48			1200	5078			✓	✓	✓	✓

Inkjet CD labels

Papier, white opaque, permanent adhesion		10 Sheets		25 Sheets		100 Sheets		Printer compatibility					
Label format (mm)	Description	Features	Labels/ sheet	Labels/ pack.	Ref. no.	Labels/ pack.	Ref. no.	Labels/ pack.	Ref. no.	Laser	Copy	Ink	Colour laser
∅ 116 Maxi	<input type="checkbox"/> white, hole diameter : 18.5 mm	<input type="checkbox"/>	2			50	4850					✓	
	<input type="checkbox"/> white, glossy, hole diameter : 18.5 mm	<input type="checkbox"/>	2	20	8885							✓	

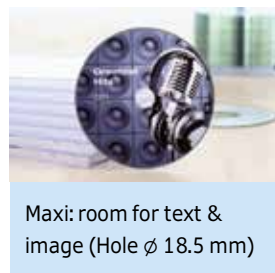
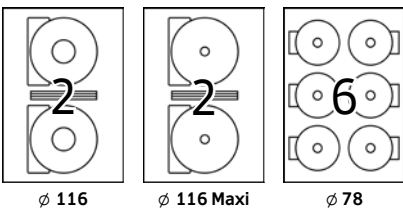

Labels for data storage

Order and overview in the data archive.

Matching CD labels: CD inlays for all common CD and DVD boxes create a uniform appearance. Highly white, stable cardboard material for best printing results. Can be cleanly separated thanks to special micro-perforation. Print lid and spine inserts in one printing process - done!

The labels for video, diskette and slide adhere securely to the rough plastic surfaces of the storage media.



CD and DVD cover inlays

- High-white, coated surface, high opacity
- Microperforation ensures clean separation, almost smooth edges
- Can also be lettered by hand
- The case and the label match perfectly – giving a professional look to every CD and DVD

Labels for diskettes, video, slides and ZIP diskettes

- Secure adhesion, easy to remove
- Precisely matched to the labelling surfaces of the storage media

CD and DVD cover inlays, card

Card, non-adhesive

Label format (mm)	Description	Features	Labels/ sheet	10 Sheets Labels/ pack.	25 Sheets Ref. no.	100 Sheets Labels/ pack.	100 Sheets Ref. no.	Printer compatibility
								Laser Copy Ink Colour laser
121.0 x 242.0	white, for slim cases, lid inlay, front and back	<input type="checkbox"/> F	1		25 5033			✓ ✓ ✓ ✓
151.0 x 118.0	white, for jewel cases, lid and rear inlay on one sheet	<input type="checkbox"/> F	1		25 5036			✓ ✓ ✓ ✓
183.0 x 273.0	white, for DVD cases, lid and rear inlay on one sheet	<input type="checkbox"/> F	1		25 5037			✓ ✓ ✓ ✓

Labels for diskettes, video, slides and ZIP diskettes

Paper, permanent adhesion

Label format (mm)	Description	Features	Labels/ sheet	10 Sheets Labels/ pack.	25 Sheets Ref. no.	100 Sheets Labels/ pack.	100 Sheets Ref. no.	Printer compatibility
								Laser Copy Ink Colour laser
70.0 x 50.8	white, 3.5" diskettes, front	<input checked="" type="checkbox"/> <input type="checkbox"/> F	10		250 4353			✓ ✓ ✓ ✓
70.0 x 67.7	white, 3.5" diskettes, front and back	<input checked="" type="checkbox"/> <input type="checkbox"/> F	8		200 4355			✓ ✓ ✓ ✓
78.7 x 46.6	white, video cassette VHS, front	<input checked="" type="checkbox"/> <input type="checkbox"/> F	12		300 5070			✓ ✓ ✓ ✓
147.3 x 20.0	white, video cassette VHS, back	<input checked="" type="checkbox"/> <input type="checkbox"/> F	13		325 5069			✓ ✓ ✓ ✓
43.2 x 8.5	white, for all slide frame sizes	<input checked="" type="checkbox"/> <input type="checkbox"/> F	128		3200 5071			✓ ✓ ✓ ✓
59.0 x 50.0	white, ZIP™ diskettes	<input checked="" type="checkbox"/> <input type="checkbox"/> F	15		375 5087			✓ ✓ ✓ ✓
63.5 x 8.5	white, data cartridges	<input checked="" type="checkbox"/> <input type="checkbox"/> F	96		2400 4202			✓ ✓ ✓ ✓

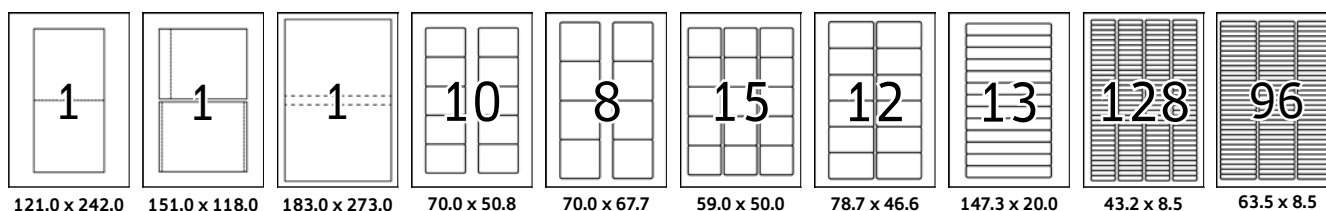

- Rounded corners
- Sheet with border on all sides
- F** FSC™-certified label material from responsibly managed forests

Removable labels

Stick on. Peel off.

HERMA labels based on removable adhesive adhere securely to any surface and can be peeled-off without residue.

Ideal for temporary or frequently changed labels and for fragile surfaces.

- Reliable adhesion on a wide range of surfaces (smooth, dry, undamaged, dust-free)
- Residue-free removal without damaging the surface
- Problem-free repositioning
- Reliable processing, even on high-speed printers and colour laser printers



Residue-free removal without damaging the surface

Removable labels

Paper, removable without residue.		10 Sheets		25 Sheets		100 Sheets		Printer compatibility					
Label format (mm)	Description	Features	Labels/ sheet	Labels/ pack.	Ref. no.	Labels/ pack.	Ref. no.	Labels/ pack.	Ref. no.	Laser	Copy	Ink	Colour laser
17.8 x 10.0	<input type="checkbox"/> white, pricing	☞	F 270			6750	10000			✓	✓	✓	✓
25.4 x 10.0	<input type="checkbox"/> white, pricing	☞	F 189			4725	10001			✓	✓	✓	✓
25.4 x 16.9	<input type="checkbox"/> white, pricing	☞	F 112			2800	4211			✓	✓	✓	✓
35.6 x 16.9	<input type="checkbox"/> white, pricing	☞	F 80			2000	10003			✓	✓	✓	✓
38.1 x 12.7	<input type="checkbox"/> white, pricing		F 110			2750	4210			✓	✓	✓	✓
38.1 x 21.2	<input type="checkbox"/> white, pricing		F 65			1625	4212			✓	✓	✓	✓
45.7 x 16.9	<input type="checkbox"/> white, tab	☞	F 64			1600	4201			✓	✓	✓	✓
45.7 x 21.2	<input type="checkbox"/> white	☞	F 48			1200	4346			✓	✓	✓	✓
52.5 x 21.2	<input type="checkbox"/> white		F 56			1400	5080			✓	✓	✓	✓
63.5 x 8.5	<input type="checkbox"/> white	☞	F 96			2400	4202			✓	✓	✓	✓
63.5 x 16.9	<input type="checkbox"/> white, inscription strips	☞	F 48			1200	10005			✓	✓	✓	✓
63.5 x 29.6	<input type="checkbox"/> white	☞	F 27			675	4347	2700	10300	✓	✓	✓	✓
63.5 x 38.1	<input type="checkbox"/> white, ideal for C6 envelope	☞	F 21			525	5074	2100	10301	✓	✓	✓	✓
63.5 x 46.6	<input type="checkbox"/> white	☞	F 18			450	4203	1800	10302	✓	✓	✓	✓
88.9 x 33.8	<input type="checkbox"/> white	☞	F 16			400	10009	1600	10303	✓	✓	✓	✓
88.9 x 46.6	<input type="checkbox"/> white	☞	F 12			300	10010	1200	10304	✓	✓	✓	✓
96.0 x 10.0	<input type="checkbox"/> white, inscription strips	☞	F 54			1350	10015			✓	✓	✓	✓
96.0 x 16.9	<input type="checkbox"/> white	☞	F 32			800	4209			✓	✓	✓	✓
96.0 x 42.3	<input type="checkbox"/> white	☞	F 12			300	4348			✓	✓	✓	✓
96.0 x 50.8	<input type="checkbox"/> white, ideal for C6 envelope ²⁾	☞	F 10			250	4349	1000	10307	✓	✓	✓	✓
96.0 x 63.5	<input type="checkbox"/> white	☞	F 8			200	4350	800	10308	✓	✓	✓	✓
99.1 x 33.8	<input type="checkbox"/> white, ideal for DL envelope	☞	F 16					1600	10309	✓	✓	✓	✓
99.1 x 38.1	<input type="checkbox"/> white, ideal for DL envelope	☞	F 14			350	10016	1400	10310	✓	✓	✓	✓
99.1 x 42.3	<input type="checkbox"/> white, ideal for DL envelope ²⁾	☞	F 12			300	10017	1200	10311	✓	✓	✓	✓
99.1 x 57.0	<input type="checkbox"/> white, ideal for C4/C5 envelope ²⁾	☞	F 10					1000	10316	✓	✓	✓	✓
99.1 x 67.7	<input type="checkbox"/> white, opaque, ideal for B4/C4-envelope ²⁾	☞	F 8			200	10018	800	10312	✓	✓	✓	✓
99.1 x 93.1	<input type="checkbox"/> white, ideal for parcels ²⁾	☞	F 6					600	10317	✓	✓	✓	✓
99.1 x 139.0	<input type="checkbox"/> white, ideal for parcels ²⁾	☞	F 4			100	10019	400	10313	✓	✓	✓	✓

Wrong label position?
No problem thanks to removable adhesive.



Removable labels

Paper, removable without residue

Label format (mm)	Description	Features	Labels/ sheet	10 Sheets		25 Sheets		100 Sheets		Printer compatibility			
				Labels/ pack.	Ref. no.	Labels/ pack.	Ref. no.	Labels/ pack.	Ref. no.	Laser	Copy	Ink	Colour laser
105.0 x 42.3	<input type="checkbox"/> white ²⁾		F 14			350	5081			✓	✓	✓	✓
105.0 x 148.0	<input type="checkbox"/> white ²⁾		F 4			100	5082			✓	✓	✓	✓
192.0 x 10.0	<input type="checkbox"/> white, inscription strips	<input type="checkbox"/>	F 27			675	10022			✓	✓	✓	✓
199.6 x 143.5	<input type="checkbox"/> white	<input type="checkbox"/>	F 2			50	10020	200	10314	✓	✓	✓	✓
210.0 x 297.0	<input type="checkbox"/> white ³⁾		F 1			25	10021	100	10315	✓	✓	✓	✓

Discover removable labels

▶ Video



Label Assistant Online

Free of charge, simple and fast:
No programme download, no software installation
Select format, design label individually, print PDF!
Always up to date with all HERMA label formats

www.herma.com/label-assistant-online

- Rounded corners
 - Sheet with border on all sides
 - F** FSC™-certified label material from responsibly managed forests
 - ³⁾ Peel-off aid on reverse (4 cuts)
- Suitable for INTERNETMARKE®:
²⁾ with recipient's address

Removable labels

Conspicuously different.

Labels in special shapes send out a special message – the shape alone adds value to the content. Ideal as advertising labels and for picking out new or special information on packaging. They also make great corporate labels on sales articles and gift packs.

- Reliable adhesion on a wide range of surfaces (smooth, dry, undamaged, dust-free)
- Residue-free removal without damaging the surface
- Problem-free repositioning
- Reliable processing, even on high-speed printers and colour laser printers



Discover removable labels



Removable labels

Paper, removable without residue.

Label format (mm)	Description	Features	Labels/ sheet	10 Sheets		25 Sheets		100 Sheets		Printer compatibility			
				Labels/ pack.	Ref. no.	Labels/ pack.	Ref. no.	Labels/ pack.	Ref. no.	Laser	Copy	Ink	Colour laser
∅ 10	white ⁵⁾	□ F	315			7875	4385			✓	✓	✓	✓
∅ 20	white ⁵⁾	□ F	96			2400	4386			✓	✓	✓	✓
∅ 30	white ⁵⁾	□ F	48			1200	4387			✓	✓	✓	✓
∅ 40	white ⁵⁾	□ F	24			600	5066	2400	4476	✓	✓	✓	✓
∅ 60	white ⁵⁾	□ F	12			300	5067	1200	4477	✓	✓	✓	✓
∅ 85	white ⁵⁾	□ F	6			150	5068	600	4478	✓	✓	✓	✓
40.6 x 25.4	white, oval ⁵⁾	□ F	36			900	4380			✓	✓	✓	✓
63.5 x 42.3	white, oval ⁵⁾	□ F	18			450	4358			✓	✓	✓	✓
24.0 x 24.0	white, square ⁵⁾	┌ □ F	70			1750	10105			✓	✓	✓	✓
25.4 x 25.4	white, square ⁵⁾	┌ □ F	66			1650	10107			✓	✓	✓	✓
40.0 x 40.0	white, square ⁵⁾	┌ □ F	24			600	10108			✓	✓	✓	✓
60.0 x 60.0	white, square ⁵⁾	┌ □ F	12			300	10109			✓	✓	✓	✓
35.6 x 16.9	white, special shape, price label	┌ □ F	80			2000	10002			✓	✓	✓	✓

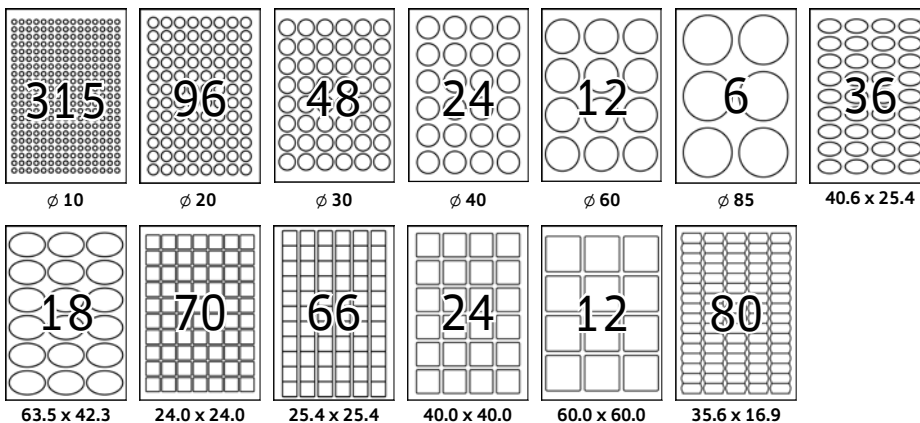

- ┌ Rounded corners
- Sheet with border on all sides
- F** FSC™-certified label material from responsibly managed forests
- ³⁾ Peel-off aid on reverse (4 cuts)
- ⁵⁾ Full-size printing (distance between the labels)

Suitable for INTERNETMARKE®:
²⁾ with recipient's address

Power labels

The labels of choice for difficult adhesion conditions.

HERMA Power labels have twice the adhesive strength of conventional paper labels. They adhere strongly even on moist, warm, cold, rough or dusty surfaces. For indoor use. For reliable labelling of products, documents and objects in inventories. For safety messages, warning messages, wrap-around labels, test badges or seal labels.

- Ideal for reliable labelling of products, documents and objects in inventories, for safety messages, warning messages, wrap-around labels, test badges or seal labels. Indoor use.
- Ideal for textured and uneven surfaces - even on curved surfaces
- 100% recyclable, dispose of as for waste paper



Power labels

Paper, white, extra strong adhesion

Label format (mm)	Description	Features	Labels/ sheet	10 Sheets		25 Sheets		100 Sheets		Printer compatibility			
				Labels/ pack.	Ref. no.	Labels/ pack.	Ref. no.	Labels/ pack.	Ref. no.	Laser	Copy	Ink	Colour laser
25.4 x 10.0	<input type="checkbox"/> white	<input checked="" type="checkbox"/> F	189		4725	10900				<input checked="" type="checkbox"/>	<input checked="" type="checkbox"/>	<input checked="" type="checkbox"/>	<input checked="" type="checkbox"/>
25.4 x 16.9	<input type="checkbox"/> white	<input checked="" type="checkbox"/> F	112		2800	10916				<input checked="" type="checkbox"/>	<input checked="" type="checkbox"/>	<input checked="" type="checkbox"/>	<input checked="" type="checkbox"/>
35.6 x 16.9	<input type="checkbox"/> white	<input checked="" type="checkbox"/> F	80		2000	10901				<input checked="" type="checkbox"/>	<input checked="" type="checkbox"/>	<input checked="" type="checkbox"/>	<input checked="" type="checkbox"/>
37.0 x 13.0	<input type="checkbox"/> white ⁵⁾	<input checked="" type="checkbox"/> F	85		2125	10917				<input checked="" type="checkbox"/>	<input checked="" type="checkbox"/>	<input checked="" type="checkbox"/>	<input checked="" type="checkbox"/>
38.1 x 21.2	<input type="checkbox"/> white	<input type="checkbox"/> F	65		1625	10913				<input checked="" type="checkbox"/>	<input checked="" type="checkbox"/>	<input checked="" type="checkbox"/>	<input checked="" type="checkbox"/>
45.7 x 21.2	<input type="checkbox"/> white	<input checked="" type="checkbox"/> F	48		1200	10902				<input checked="" type="checkbox"/>	<input checked="" type="checkbox"/>	<input checked="" type="checkbox"/>	<input checked="" type="checkbox"/>
48.3 x 25.4	<input type="checkbox"/> white	<input type="checkbox"/> F	44		1100	10914				<input checked="" type="checkbox"/>	<input checked="" type="checkbox"/>	<input checked="" type="checkbox"/>	<input checked="" type="checkbox"/>
63.5 x 29.6	<input type="checkbox"/> white	<input checked="" type="checkbox"/> F	27		675	10903				<input checked="" type="checkbox"/>	<input checked="" type="checkbox"/>	<input checked="" type="checkbox"/>	<input checked="" type="checkbox"/>
70.0 x 36.0	<input type="checkbox"/> white ^{1,1)}	<input type="checkbox"/> F	24		600	10905				<input checked="" type="checkbox"/>	<input checked="" type="checkbox"/>	<input checked="" type="checkbox"/>	<input checked="" type="checkbox"/>
70.0 x 42.3	<input type="checkbox"/> white ^{1,1)}	<input type="checkbox"/> F	21		525	10906				<input checked="" type="checkbox"/>	<input checked="" type="checkbox"/>	<input checked="" type="checkbox"/>	<input checked="" type="checkbox"/>
97.0 x 42.3	<input type="checkbox"/> white ²⁾	<input type="checkbox"/> F	12		300	10907				<input checked="" type="checkbox"/>	<input checked="" type="checkbox"/>	<input checked="" type="checkbox"/>	<input checked="" type="checkbox"/>
105.0 x 48.0	<input type="checkbox"/> white ²⁾	<input type="checkbox"/> F	12		300	10908				<input checked="" type="checkbox"/>	<input checked="" type="checkbox"/>	<input checked="" type="checkbox"/>	<input checked="" type="checkbox"/>
105.0 x 148.0	<input type="checkbox"/> white ²⁾	<input type="checkbox"/> F	4		100	10909				<input checked="" type="checkbox"/>	<input checked="" type="checkbox"/>	<input checked="" type="checkbox"/>	<input checked="" type="checkbox"/>
210.0 x 148.0	<input type="checkbox"/> white ²⁾	<input type="checkbox"/> F	2		50	10910				<input checked="" type="checkbox"/>	<input checked="" type="checkbox"/>	<input checked="" type="checkbox"/>	<input checked="" type="checkbox"/>
210.0 x 297.0	<input type="checkbox"/> white ³⁾	<input type="checkbox"/> F	1		25	10911				<input checked="" type="checkbox"/>	<input checked="" type="checkbox"/>	<input checked="" type="checkbox"/>	<input checked="" type="checkbox"/>
∅ 30	<input type="checkbox"/> white ⁵⁾	<input type="checkbox"/> F	48		1200	10915				<input checked="" type="checkbox"/>	<input checked="" type="checkbox"/>	<input checked="" type="checkbox"/>	<input checked="" type="checkbox"/>

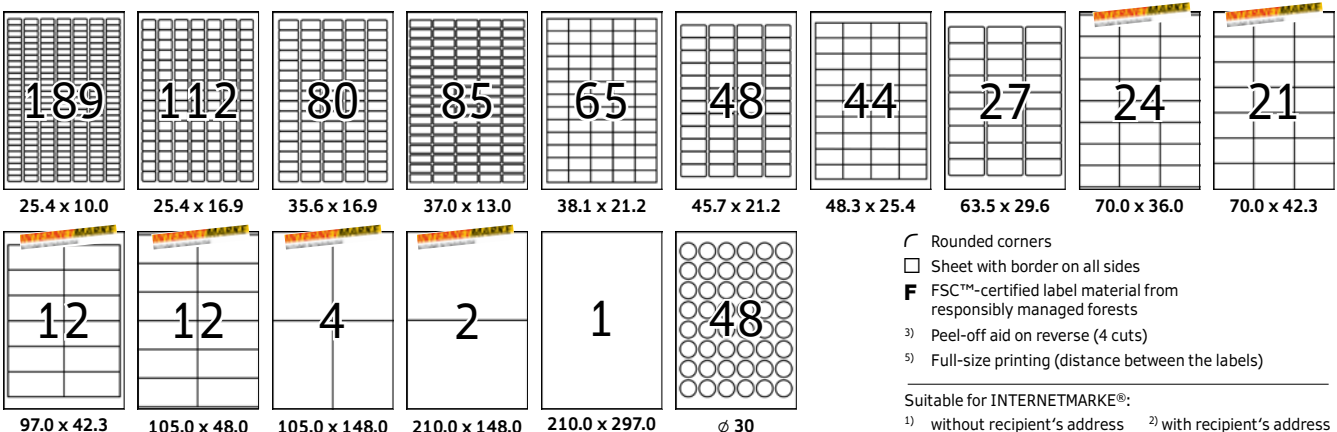

- Rounded corners
- Sheet with border on all sides
- F** FSC™-certified label material from responsibly managed forests
- ³⁾ Peel-off aid on reverse (4 cuts)
- ⁵⁾ Full-size printing (distance between the labels)

Suitable for INTERNETMARKE®:

- ¹⁾ without recipient's address
- ²⁾ with recipient's address

Coloured labels

Coloured labels sending signals.

They ensure better organization and clarity with colour identification of documents, samples, dispatch papers etc. They draw attention to important information, rush notices or messages on letters or packages, such as „Important: new telephone number“, „Urgent“, „Caution: Glass“ or „Special Offer“. Ideal for product promotion labels, for conspicuous labelling in warehouses and in logistics, and for all kinds of colour codes.

- Ideal for important notices and promotion stickers
- For labels used as signalling devices, e.g. warning notices, urgent memos, change of address, coloured coding, promotions, etc.
- Yellow, red, blue and green labels are perfect for calling attention to information that mustn't be overlooked



Coloured labels

Paper, permanent adhesion (100 sheets), removable (20 sheets)

Label format (mm)	Description	Features	Labels/ sheet	10 Sheets		20 Sheets *		100 Sheets **		Printer compatibility			
				Labels/ pack.	Ref. no.	Labels/ pack.	Ref. no.	Labels/ pack.	Ref. no.	Laser	Copy	Ink	Colour laser
25.4 x 10.0	yellow	☐	F 189			3780	4243	18900	4237	✓	✓	✓	✓
	red	☐	F 189			3780	4244	18900	4238	✓	✓	✓	✓
45.7 x 21.2	yellow	☐	F 48			960	4366	4800	4544	✓	✓	✓	✓
	red	☐	F 48			960	4367	4800	4545	✓	✓	✓	✓
	blue	☐	F 48			960	4368	4800	4547	✓	✓	✓	✓
	green	☐	F 48			960	4369	4800	4549	✓	✓	✓	✓
70.0 x 37.0	yellow		F 24			480	4466	2400	4406	✓	✓	✓	✓
	red		F 24			480	4467	2400	4407	✓	✓	✓	✓
	blue		F 24			480	4468	2400	4408	✓	✓	✓	✓
	green		F 24			480	4469	2400	4409	✓	✓	✓	✓
105.0 x 37.0	yellow		F 16			320	4551	1600	4256	✓	✓	✓	✓
	red		F 16			320	4552	1600	4257	✓	✓	✓	✓
	blue		F 16			320	4553	1600	4258	✓	✓	✓	✓
	green		F 16			320	4554	1600	4259	✓	✓	✓	✓
105.0 x 42.3	yellow		F 14			280	5058	1400	4555	✓	✓	✓	✓
	red		F 14			280	5059	1400	4557	✓	✓	✓	✓
	blue		F 14			280	5060	1400	4558	✓	✓	✓	✓
	green		F 14			280	5061	1400	4559	✓	✓	✓	✓
105.0 x 148.0	yellow		F 4			80	4561	400	4396	✓	✓	✓	✓
	red		F 4			80	4562	400	4397	✓	✓	✓	✓
	blue		F 4			80	4563	400	4398	✓	✓	✓	✓
	green		F 4			80	4564	400	4399	✓	✓	✓	✓
199.6 x 143.5	yellow	☐	F 2			40	4496	200	4565	✓	✓	✓	✓
	red	☐	F 2			40	4497	200	4567	✓	✓	✓	✓
	green	☐	F 2			40	4498	200	4568	✓	✓	✓	✓
	green	☐	F 2			40	4499	200	4569	✓	✓	✓	✓
210.0 x 297.0	yellow ³⁾		F 1			20	4421	100	4401	✓	✓	✓	✓
	red ³⁾		F 1			20	4422	100	4402	✓	✓	✓	✓
	blue ³⁾		F 1			20	4423	100	4403	✓	✓	✓	✓
	green ³⁾		F 1			20	4424	100	4404	✓	✓	✓	✓

Neon labels

Eye-catching and informative!

For mailings, warning notices or urgent memos, maximum impact for promotion campaigns, products and special offers for important notices in the warehouse, factory or logistics. For drawing attention to important information on products, packaging and sales documents. For colour identification of documents, samples, dispatch papers.

- Striking colours for maximum effect
- Ideal for posting eye-catching information e.g. warning notices, urgent memos, change of address, coloured coding
- Maximum impact for promotion campaigns, products and special offers



Neon labels

Paper, permanent adhesion

Label format (mm)	Description	Features	Labels/ sheet	10 Sheets		20 Sheets		100 Sheets		Printer compatibility			
				Labels/ pack.	Ref. no.	Labels/ pack.	Ref. no.	Labels/ pack.	Ref. no.	Laser	Copy	Ink	Colour laser
63.5 x 29.6	neon yellow	☐	F 27			540	5140			✓	✓	✓	✓
	neon red	☐	F 27			540	5045			✓	✓	✓	✓
	neon orange	☐	F 27			540	5141			✓	✓	✓	✓
	neon green	☐	F 27			540	5143			✓	✓	✓	✓
99.1 x 67.7	neon yellow	☐	F 8			160	5144			✓	✓	✓	✓
	neon red	☐	F 8			160	5046			✓	✓	✓	✓
	neon orange	☐	F 8			160	5145			✓	✓	✓	✓
	neon green	☐	F 8			160	5147			✓	✓	✓	✓
210.0 x 297.0	neon yellow ³⁾		F 1			20	5148			✓	✓	✓	✓
	neon-red ³⁾		F 1			20	5048			✓	✓	✓	✓
	neon orange ³⁾		F 1			20	5149			✓	✓	✓	✓
	neon green ³⁾		F 1			20	5151			✓	✓	✓	✓
∅ 60	neon yellow ⁵⁾	☐	F 12			240	5152			✓	✓	✓	✓
	neon-red ⁵⁾	☐	F 12			240	5156			✓	✓	✓	✓
	neon orange ⁵⁾	☐	F 12			240	5153			✓	✓	✓	✓
	neon green ⁵⁾	☐	F 12			240	5155			✓	✓	✓	✓

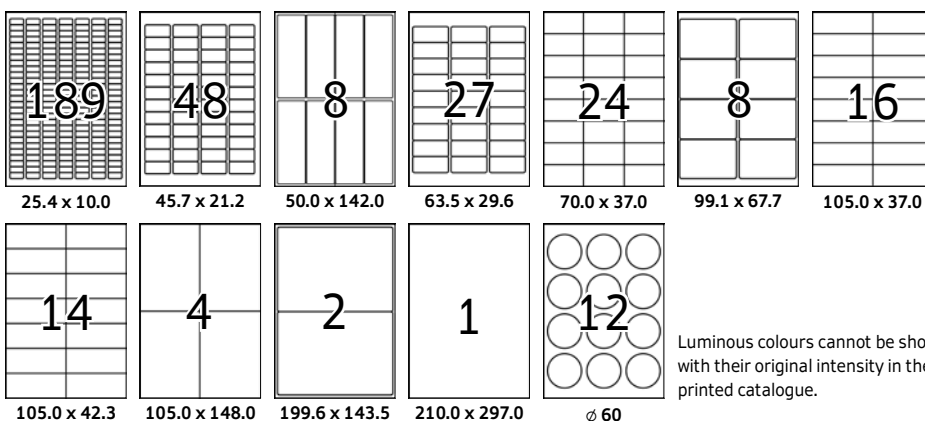

Luminous colours cannot be shown with their original intensity in the printed catalogue.

- ☐ Rounded corners
- ☐ Sheet with border on all sides
- F** FSC™-certified label material from responsibly managed forests
- ³⁾ Peel-off aid on reverse (4 cuts)
- ⁵⁾ Full-size printing (distance between the labels)

Labels made of recycled paper

Great for the environment and for the climate.

That's because the label material is made exclusively from recycled paper. The natural white label material is unusually bright, with high purity. The paper fulfills the requirements of DIN 6738 (age resistance). The water-based adhesive is free of plasticizers, acids and solvents, and the packaging is made of recycled cardboard.

- High brightness and purity thanks to wastepaper selection, without the use of chlorine bleach or whitening agents (brightness ISO 97% / CIE 133)
- Smooth surface, high covering capacity
- 100% recyclable, dispose of as for waste paper
- Excellent environmentally friendly, with Blue Angel



www.blauer-engel.de/uz14b

Labels made of recycled paper

Label material made of 100% recycled paper, permanent adhesion

Label format (mm)	Description	Features	Labels/ sheet	10 Sheets		20 Sheets		80 Sheets		Printer compatibility			
				Labels/ pack.	Ref. no.	Labels/ pack.	Ref. no.	Labels/ pack.	Ref. no.	Laser	Copy	Ink	Colour laser
25.4 x 10.0	<input type="checkbox"/> naturweiß	☞ <input type="checkbox"/> B	189			3780	10700			✓	✓	✓	✓
35.6 x 16.9	<input type="checkbox"/> natural-white	☞ <input type="checkbox"/> B	80			1600	10701			✓	✓	✓	✓
38.1 x 21.2	<input type="checkbox"/> natural-white	<input type="checkbox"/> B	65					5200	10725	✓	✓	✓	✓
48.3 x 25.4	<input type="checkbox"/> natural-white	<input type="checkbox"/> B	44					3520	10726	✓	✓	✓	✓
48.3 x 33.8	<input type="checkbox"/> natural-white	<input type="checkbox"/> B	32			640	10702			✓	✓	✓	✓
63.5 x 38.1	<input type="checkbox"/> natural-white, ideal for C6 envelope	☞ <input type="checkbox"/> B	21					1680	10727	✓	✓	✓	✓
70.0 x 36.0	<input type="checkbox"/> natural-white ¹⁾	<input type="checkbox"/> B	24			480	10703	1960	10728	✓	✓	✓	✓
70.0 x 37.0	<input type="checkbox"/> natural-white	<input type="checkbox"/> B	24					1960	10729	✓	✓	✓	✓
97.0 x 42.3	<input type="checkbox"/> natural-white	<input type="checkbox"/> B	12			240	10704			✓	✓	✓	✓
99.1 x 33.8	<input type="checkbox"/> natural-white, ideal for DL envelopes	☞ <input type="checkbox"/> B	16					1280	10730	✓	✓	✓	✓
99.1 x 38.1	<input type="checkbox"/> natural-white, ideal for DL envelopes	☞ <input type="checkbox"/> B	14					1120	10731	✓	✓	✓	✓
99.1 x 67.7	<input type="checkbox"/> natural-white, ideal for B4/C4 ²⁾	☞ <input type="checkbox"/> B	8			160	10705	640	10732	✓	✓	✓	✓
105.0 x 48.0	<input type="checkbox"/> natural-white ²⁾	<input type="checkbox"/> B	12					960	10733	✓	✓	✓	✓
105.0 x 148.0	<input type="checkbox"/> natural-white ²⁾	<input type="checkbox"/> B	4			80	10706	320	10734	✓	✓	✓	✓
199.6 x 143.5	<input type="checkbox"/> natural-white, ideal for parcels ²⁾	☞ <input type="checkbox"/> B	2					160	10735	✓	✓	✓	✓
199.6 x 289.1	<input type="checkbox"/> natural-white, ideal for parcels	☞ <input type="checkbox"/> B	1					80	10736	✓	✓	✓	✓
210.0 x 148.0	<input type="checkbox"/> natural-white ²⁾	<input type="checkbox"/> B	2			40	10707	160	10737	✓	✓	✓	✓
210.0 x 297.0	<input type="checkbox"/> natural-white ³⁾	<input type="checkbox"/> B	1			20	10708	80	10738	✓	✓	✓	✓
192.0 x 38.0	<input type="checkbox"/> natural-white, for narrow files	☞ <input type="checkbox"/> B	7			140	10745	560	10739	✓	✓	✓	✓
192.0 x 61.0	<input type="checkbox"/> natural-white, for wide files	☞ <input type="checkbox"/> B	4			80	10746	320	10740	✓	✓	✓	✓

- ☞ Rounded corners
- Sheet with border on all sides
- B** „Blue Angel“ certification

³⁾ Peel-off aid on reverse (4 cuts)

Suitable for INTERNETMARKE®:

- ¹⁾ without recipient's address
- ²⁾ with recipient's address

Labels made of silphie paper

Naturally handsome.

Special paper made from the queen of ecological crops: Danube silphie. An important habitat for bees, cultivated as an energy crop, ideal for binding CO₂, valuable for the ecosystem. Whether as product, folder, identification or closure labels - the silphie-labels already signal visually: a contribution to sustainability.

- Grown in Germany, short transport routes, lower CO₂ emissions
- Modern kraft paper look, with at least 35 % silphie fibre content
- Very good processing on laser and inkjet printers and copiers in black and colour



Labels made of silphie paper

Label material with at least 35 % silphie fibre content, permanent adhesion

Label format (mm)	Description	Features	Labels/ sheet	10 Sheets		20 Sheets		100 Sheets		Printer compatibility			
				Labels/ pack.	Ref. no.	Labels/ pack.	Ref. no.	Labels/ pack.	Ref. no.	Laser	Copy	Ink	Colour laser
25.4 x 10.0	<input type="checkbox"/> natural-brown	<input checked="" type="checkbox"/> F	189		3680	10750				<input checked="" type="checkbox"/>	<input checked="" type="checkbox"/>	<input checked="" type="checkbox"/>	<input checked="" type="checkbox"/>
35.6 x 16.9	<input type="checkbox"/> natural-brown	<input checked="" type="checkbox"/> F	80		1600	10751				<input checked="" type="checkbox"/>	<input checked="" type="checkbox"/>	<input checked="" type="checkbox"/>	<input checked="" type="checkbox"/>
48.3 x 33.8	<input type="checkbox"/> natural-brown	<input type="checkbox"/> F	32		640	10752				<input checked="" type="checkbox"/>	<input checked="" type="checkbox"/>	<input checked="" type="checkbox"/>	<input checked="" type="checkbox"/>
70.0 x 36.0	<input type="checkbox"/> natural-brown ¹⁾	<input type="checkbox"/> F	24		480	10753				<input checked="" type="checkbox"/>	<input checked="" type="checkbox"/>	<input checked="" type="checkbox"/>	<input checked="" type="checkbox"/>
97.0 x 42.3	<input type="checkbox"/> natural-brown	<input type="checkbox"/> F	12		240	10754				<input checked="" type="checkbox"/>	<input checked="" type="checkbox"/>	<input checked="" type="checkbox"/>	<input checked="" type="checkbox"/>
99.1 x 67.7	<input type="checkbox"/> natural-brown, ideal for B4/C4 ²⁾	<input checked="" type="checkbox"/> F	8		160	10755				<input checked="" type="checkbox"/>	<input checked="" type="checkbox"/>	<input checked="" type="checkbox"/>	<input checked="" type="checkbox"/>
105.0 x 148.0	<input type="checkbox"/> natural-brown ²⁾	<input type="checkbox"/> F	4		80	10756				<input checked="" type="checkbox"/>	<input checked="" type="checkbox"/>	<input checked="" type="checkbox"/>	<input checked="" type="checkbox"/>
210.0 x 148.0	<input type="checkbox"/> natural-brown ²⁾	<input type="checkbox"/> F	2		40	10757				<input checked="" type="checkbox"/>	<input checked="" type="checkbox"/>	<input checked="" type="checkbox"/>	<input checked="" type="checkbox"/>
210.0 x 297.0	<input type="checkbox"/> natural-brown ³⁾	<input type="checkbox"/> F	1		20	10758				<input checked="" type="checkbox"/>	<input checked="" type="checkbox"/>	<input checked="" type="checkbox"/>	<input checked="" type="checkbox"/>
192.0 x 38.0	<input type="checkbox"/> natural-brown, for narrow files	<input checked="" type="checkbox"/> F	7		140	10759				<input checked="" type="checkbox"/>	<input checked="" type="checkbox"/>	<input checked="" type="checkbox"/>	<input checked="" type="checkbox"/>
192.0 x 61.0	<input type="checkbox"/> natural-brown, for wide files	<input checked="" type="checkbox"/> F	4		80	10760				<input checked="" type="checkbox"/>	<input checked="" type="checkbox"/>	<input checked="" type="checkbox"/>	<input checked="" type="checkbox"/>

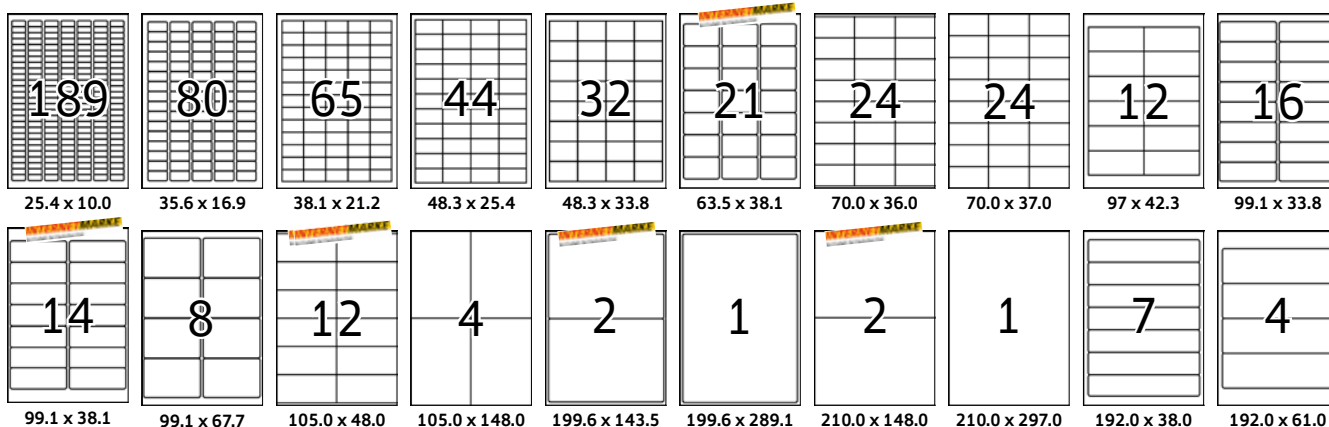

- Rounded corners
- Sheet with border on all sides
- F** FSC™-certified label material from responsibly managed forests

³⁾ Peel-off aid on reverse (4 cuts)

Suitable for INTERNETMARKE®:
¹⁾ without recipient's address
²⁾ with recipient's address

Inkjet labels for general use. photo-quality

The paper is what makes the difference.

HERMA Inkjet labels are made of specially finished, coated 90 g paper. Superior photo-quality prints become a reality. Instant drying and wipe resistant, in black and white and colour, due to special coating. The printed result is razorsharp; small fonts and barcodes are clearly defined.

- Specially designed for inkjet printers – special coated paper 90 g/m²
- Razor-sharp contours, brilliant colours
- Glitch-free printing even with paper guides that are less than reliable



Inkjet labels for general use. photo-quality

Special coated paper. quick-drying. photo quality. permanent adhesion

Label format (mm)	Description	Features	Labels/ sheet	10 Sheets		25 Sheets		80 Sheets		Printer compatibility			
				Labels/ pack.	Ref. no.	Labels/ pack.	Ref. no.	Labels/ pack.	Ref. no.	Laser	Copy	Ink	Colour laser
25.4 x 8.5	<input type="checkbox"/> white, matt	┌ □	224			5600	8830						✓
25.4 x 25.4	<input type="checkbox"/> white, matt	┌ □	66			1650	8831						✓
30.5 x 16.9	<input type="checkbox"/> white, matt	┌ □	96			2400	8832						✓
38.1 x 21.2	<input type="checkbox"/> white, matt	□	65					5200	10778				✓
45.7 x 21.2	<input type="checkbox"/> white, matt	┌ □	48			1200	8864						✓
63.5 x 25.4	<input type="checkbox"/> white, matt	┌ □	33			825	8837						✓
63.5 x 38.1	<input type="checkbox"/> white, matt	┌ □	21			525	8838						✓
66.0 x 33.8	<input type="checkbox"/> white, matt ¹⁾	□	24			600	4820	1920	10779				✓
83.8 x 50.8	<input type="checkbox"/> white, matt. approx. business card size	┌ □	10			250	8840						✓
88.9 x 46.6	<input type="checkbox"/> white, matt	┌ □	12			300	8842	960	10776				✓
97.0 x 33.8	<input type="checkbox"/> white, matt	□	16					1280	10780				✓
97.0 x 42.3	<input type="checkbox"/> white, matt ²⁾	□	12			300	4823	960	10781				✓
96.0 x 139.7	<input type="checkbox"/> white, matt	┌ □	4					320	10777				✓
210.0 x 297.0	<input type="checkbox"/> white, matt ⁴⁾		1				25	4824	80	10782			✓

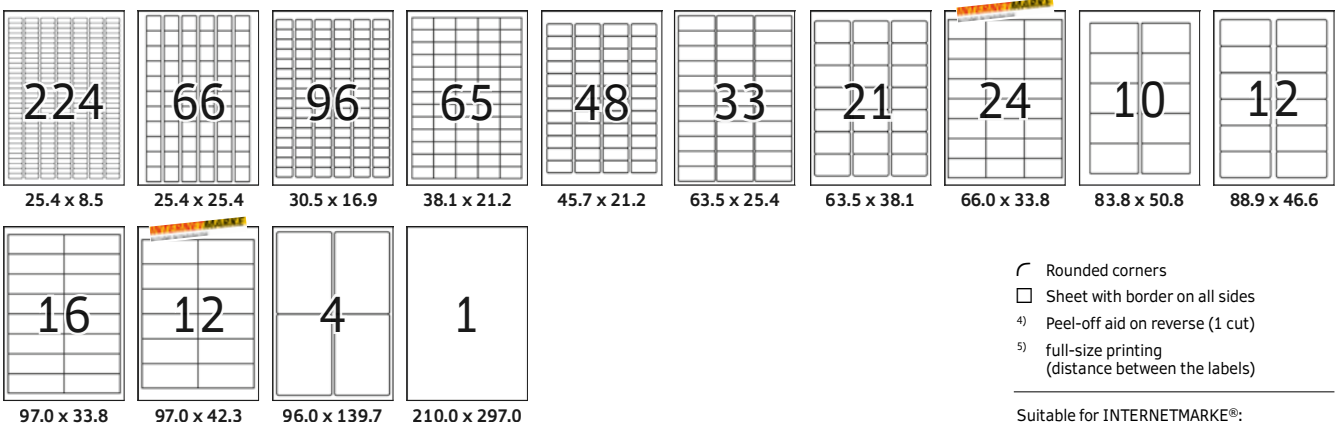

- ┌ Rounded corners
- Sheet with border on all sides
- ⁴⁾ Peel-off aid on reverse (1 cut)
- ⁵⁾ full-size printing (distance between the labels)

Suitable for INTERNETMARKE®:
¹⁾ without recipient's address
²⁾ with recipient's address

Inkjet film labels / Inkjet Glossy labels

Deliver what they promise.

HERMA inkjet film labels produce outstanding print results in black and colour. Thanks to a special surface coating, the labels ensure optimum ink absorption for outdoor labelling or as visually outstanding lettering.



Weatherproof inkjet film labels

- Special coating for waterresistant inkjet prints
- White opaque film. matt. permanent adhesion. In A4 format also available in transparent glossy material

High-gloss labels for inkjet printers. photo quality

- Ideal as high-quality, colourintensive labels for wine and champagne bottles, preserving jars, home-made gifts from the kitchen and much more
- Instant-drying, extremely smudge-resistant, lightfast, opaque and cold-resistant

Weatherproof inkjet film labels

Polypropylene film, permanent adhesion

Label format (mm)	Description	Features	Labels/ sheet	10 Sheets		40 Sheets		100 Sheets		Printer compatibility			
				Labels/ pack.	Ref. no.	Labels/ pack.	Ref. no.	Labels/ pack.	Ref. no.	Laser	Copy	Ink	Colour laser
63.5 x 29.6	<input type="checkbox"/> white, matt	☐	27	270	4864	1080	4594						✓
97.0 x 42.3	<input type="checkbox"/> white, matt	☐	12	120	4595	480	4597						✓
105.0 x 148.0	<input type="checkbox"/> white, matt		4	40	4598	160	4599						✓
210.0 x 148.0	<input type="checkbox"/> white, matt		2	20	4600	80	4601						✓
210.0 x 297.0	<input type="checkbox"/> white, matt ⁴⁾		1	10	4866	40	4602						✓
210.0 x 297.0	transparent, crystal-clear ⁴⁾		1	10	8964								✓

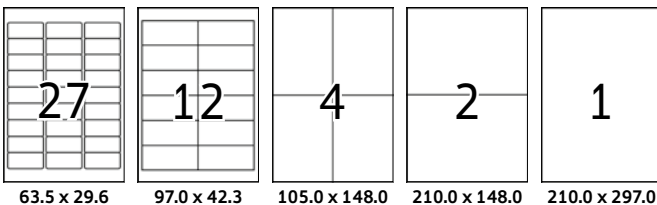

High-gloss labels for inkjet printers. photo quality

Glossy paper, permanent adhesion

Label format (mm)	Description	Features	Labels/ sheet	10 Sheets		40 Sheets		100 Sheets		Printer compatibility			
				Labels/ pack.	Ref. no.	Labels/ pack.	Ref. no.	Labels/ pack.	Ref. no.	Laser	Copy	Ink	Colour laser
90.0 x 120.0	<input type="checkbox"/> white, glossy, bottle labels ⁵⁾	☐	4	40	8882	160	4603						✓
210.0 x 297.0	<input type="checkbox"/> white, glossy ⁴⁾		1	10	8895								✓

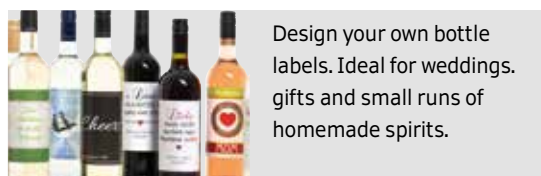
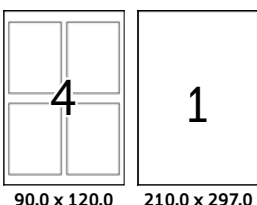

Design your own bottle labels. Ideal for weddings, gifts and small runs of homemade spirits.



A4 format. can be custom-printed and tailored to suit the object in hand.

Inkjet file spine labels / Inkjet CD labels

For a brilliant appearance on the shelf and in the CD case.

The white, self-adhesive folder and CD labels are available especially for inkjet printers. They are ideal for colour-intensive printouts with contour sharpness.

- Specially designed for inkjet printers – special coated paper 90 g/m², instant-drying ...
- Razor-sharp contours and brilliant colours
- Glitch-free printing even with paper guides that are less than reliable



File spine labels

- Reliable adhesion, even with frequently used files

CD labels

- Positioning aid at each label

Inkjet file spine labels

Special coated paper, permanent adhesion		10 Sheets	25 Sheets	100 Sheets	Printer compatibility						
Label format (mm)	Description	Labels/ pack.	Ref. no.	Labels/ pack.	Ref. no.	Labels/ pack.	Ref. no.	Laser	Copy	Ink	Colour laser
Leitz, Elba, Esselte, Mehle, Herlitz, Bene:											
192.0 x 38.0	<input type="checkbox"/> white, narrow, short	7		175	4825						✓
Leitz, Elba, Mehle, Bene, Biella:											
192.0 x 61.0	<input type="checkbox"/> white, wide, short	4		100	4826						✓
Leitz, Elba, Esselte, Mehle, Herlitz, Bene:											
38.0 x 297.0	<input type="checkbox"/> white, narrow, long, thumb hole	5		125	4830						✓
Leitz, Elba, Mehle, Bene, Biella:											
61.0 x 297.0	<input type="checkbox"/> white, wide, long, thumb hole	3		75	4831						✓

Inkjet CD labels

Special coated paper, photo quality, permanent adhesion		10 Sheets	25 Sheets	100 Sheets	Printer compatibility						
Label format (mm)	Description	Labels/ pack.	Ref. no.	Labels/ pack.	Ref. no.	Labels/ pack.	Ref. no.	Laser	Copy	Ink	Colour laser
∅ 116 Maxi	<input type="checkbox"/> white, hole diameter : 18.5 mm	2		50	4850						✓
	<input type="checkbox"/> white, glossy, hole diameter : 18.5 mm	2	20	8885							✓

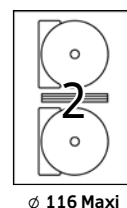
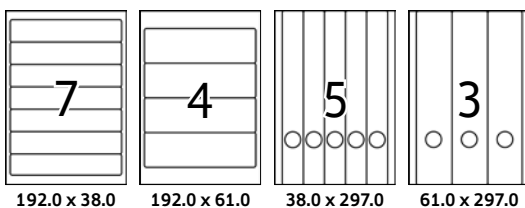

High-gloss labels for laser printers and copiers

Rise and shine!

High-gloss labels from HERMA give an especially chic look to your brochures, catalogues, products and presentations. They are ideal for printing out photos and images. For colour-intensive printouts with razor-sharp contours.

- Glossy paper with high opacity, for colour-intensive print-outs with razor-sharp contours
- Ideal for high-quality product stickers, photographic prints, marketing and advertising presentations ...
- Give a first-class look to folders, catalogues and brochures
- Reliable adhesion on all surfaces



High-gloss labels for laser printers and copiers

Label format (mm)	Description	Features	Labels/ sheet	10 Sheets		25 Sheets		100 Sheets		Printer compatibility		
				Labels/ pack.	Ref. no.	Labels/ pack.	Ref. no.	Labels/ pack.	Ref. no.	Laser	Copy	Ink
63.5 x 38.1	<input type="checkbox"/> white, glossy	<input checked="" type="checkbox"/> F	21			525	4904			<input checked="" type="checkbox"/>	<input checked="" type="checkbox"/>	<input checked="" type="checkbox"/>
88.9 x 46.6	<input type="checkbox"/> white, glossy	<input checked="" type="checkbox"/> F	12			300	4906			<input checked="" type="checkbox"/>	<input checked="" type="checkbox"/>	<input checked="" type="checkbox"/>
96.0 x 63.5	<input type="checkbox"/> white, glossy	<input checked="" type="checkbox"/> F	8			200	4907			<input checked="" type="checkbox"/>	<input checked="" type="checkbox"/>	<input checked="" type="checkbox"/>
96.0 x 139.7	<input type="checkbox"/> white, glossy	<input checked="" type="checkbox"/> F	4			100	4908			<input checked="" type="checkbox"/>	<input checked="" type="checkbox"/>	<input checked="" type="checkbox"/>
199.6 x 143.5	<input type="checkbox"/> white, glossy	<input checked="" type="checkbox"/> F	2			50	4915			<input checked="" type="checkbox"/>	<input checked="" type="checkbox"/>	<input checked="" type="checkbox"/>
210.0 x 297.0	<input type="checkbox"/> white, glossy ⁴⁾	F	1			25	4909			<input checked="" type="checkbox"/>	<input checked="" type="checkbox"/>	<input checked="" type="checkbox"/>

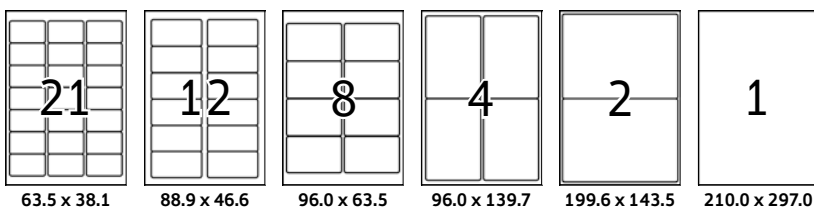

Inkjet glossy labels can be found on page 39.



Label Assistant Online

- Free of charge, simple and fast:
- No programme download, no software installation
- Select format, design label individually, print PDF!
- Always up to date with all HERMA label formats

www.herma.com/label-assistant-online

- Rounded corners
- Sheet with border on all sides
- ⁴⁾ Peel-off aid on reverse (1 cut)

Name/textile labels

Make a good impression. but don't make holes in clothing.

For professional events from the very beginning. The self-adhesive name/textile labels made of high-quality artificial silk are a practical and inexpensive alternative to plastic badges. HERMA name labels are quick to inscribe (using a PC or by hand) and provide firm adhesion without the need for a pin or clip. They can simply be peeled off.

- Flexible textile material reliable adhesion. easy to remove
- Name labels for seminars, conferences, trade fairs
- Ideal for labelling of materials, carpets, mattresses
- Caution: these labels should not be applied to fine leather or textiles such as silk or velvet as they may leave marks

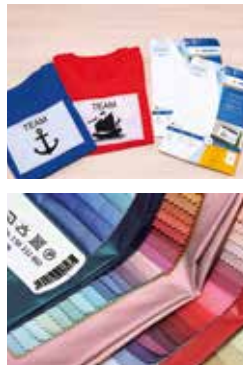

Discover name labels



Name/textile labels

Artificial silk, removable				10 Sheets	20 Sheets	25 Sheets	Printer compatibility						
Label format (mm)	Description	Features	Labels/sheet	Labels/pack.	Ref. no.	Labels/pack.	Ref. no.	Labels/pack.	Ref. no.	Laser	Copy	Ink	Colour laser
63.5 x 29.6	white	☐	27			540	4511			✓	✓	✓	
63.5 x 29.6	white, with red stripe	☐	27			540	4512			✓	✓	✓	
63.5 x 29.6	white, with blue stripe	☐	27			540	4513			✓	✓	✓	
80.0 x 50.0	white, individually separable* ⁵⁾	☐	10	100	4587	200	4514	250	4412	✓	✓	✓	✓
80.0 x 50.0	white, with red frame* ⁵⁾	☐	10			200	4405			✓	✓	✓	✓
80.0 x 50.0	white, with blue frame* ⁵⁾	☐	10			200	4410			✓	✓	✓	✓
88.9 x 33.8	white	☐	16	160	4588	320	4515			✓	✓	✓	✓
199.6 x 143.5	white	☐	2			40	4519			✓	✓	✓	✓

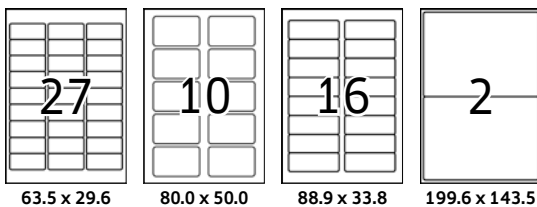

* The perforation on the back allows the printed labels to be removed from the sheet along with the backing for immediate or later use.



- ☐ Rounded corners
- ☐ Sheet with border on all sides
- ⁵⁾ Full-size printing (distance between the labels)

Inserts for name badges / Spine insert labels / CD inlays

Microperforation ensures clean separation.

Inserts for name badges made of carton. can be inserted into all standard-size name badges with a clip or magnet. ideal for seminars. conferences. trade fairs.

Spine insert labels. fit files with spine insert. simply remove and replace

CD and DVD cover inlays. for all common CD boxes: Print lid and rear inlay on one sheet in a single print run – done!

- High-white coated surface. high opacity
- Blank: ideal for company logos and individual colour coding
- Microperforation ensures clean separation. almost smooth edges
- Can also be lettered by hand



Inserts / CD and DVD cover inlays

Cardboard. non-adhesive. microperforation

Label format (mm)	Description	Features	Labels/ sheet	Labels/ pack.	Ref. no.	10 Sheets	25 Sheets	100 Sheets	Printer compatibility
									Laser Copy Ink Colour laser
Insert labels for name badges and company logo									
75.0 x 40.0	<input type="checkbox"/> white	<input type="checkbox"/> F	12				300	9010	✓ ✓ ✓ ✓
90.0 x 54.0	<input type="checkbox"/> white	<input type="checkbox"/> F	10				250	9011	✓ ✓ ✓ ✓
90.0 x 60.0	<input type="checkbox"/> white	<input type="checkbox"/> F	8				200	9012	✓ ✓ ✓ ✓
Insert labels for spine insert labels									
Astor. Biella. Ordex. Esselte									
143.0 x 28.0	<input type="checkbox"/> white. narrow. for Swiss federal folder	<input type="checkbox"/> F	9				225	65123	✓ ✓ ✓ ✓
Astor. Biella. Ordex. Esselte. Leitz Swiss Edition									
146.0 x 50.0	<input type="checkbox"/> white. wide. for Swiss federal folder	<input type="checkbox"/> F	5				125	65121	✓ ✓ ✓ ✓
Leitz. Elba. EJA. Falken:									
190.0 x 30.0	<input type="checkbox"/> white. narrow. name badges	<input type="checkbox"/> F	9				225	5122	✓ ✓ ✓ ✓
Leitz. Elba. EJA. Falken:									
190.0 x 54.0	<input type="checkbox"/> white wide. name badges	<input type="checkbox"/> F	5				125	5032	✓ ✓ ✓ ✓
CD and DVD cover inlays									
121.0 x 242.0	<input type="checkbox"/> white. for slim cases. lid inlay. front and back	<input type="checkbox"/> F	1				25	5033	✓ ✓ ✓ ✓
151.0 x 118.0	<input type="checkbox"/> white. for jewel cases. lid and rear inlay on one sheet	<input type="checkbox"/> F	1				25	5036	✓ ✓ ✓ ✓
183.0 x 273.0	<input type="checkbox"/> white. for DVD cases. lid and rear inlay on one sheet	<input type="checkbox"/> F	1				25	5037	✓ ✓ ✓ ✓

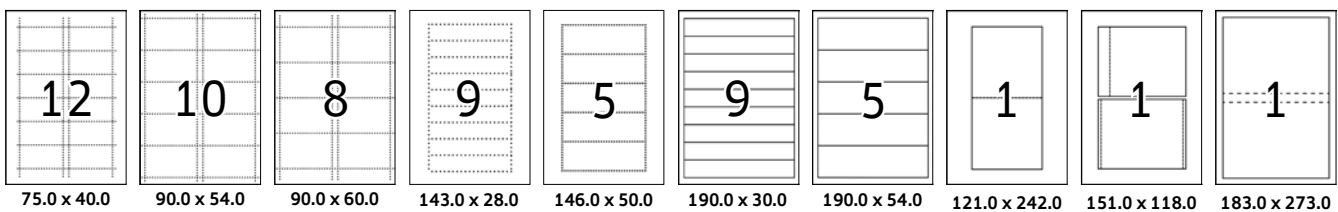

- Sheet with border on all sides
- F** FSC™-certified label material from responsibly managed forests

Weatherproof labels

Hard-wearing in wind and weather.

Ideal for labelling goods and containers. Information or warning signs outdoors thanks to special paper with weatherproof impregnation. Thanks to extremely strong adhesion, the weather-resistant labels also have a secure hold even on critical surfaces.

- Impregnated special paper with extremely strong adhesion, even on critical surfaces
- Weather-resistant, resistant to ageing, oil and dirt repellent, wet wipeable, resistant to temperatures between -30 and +80 °C



Weatherproof labels

Impregnated special paper, extra strong adhesion

Label format (mm)	Description	Features	Labels/ sheet	10 Sheets		25 Sheets		80 Sheets		Printer compatibility		
				Labels/ pack.	Ref. no.	Labels/ pack.	Ref. no.	Labels/ pack.	Ref. no.	Laser	Copy	Ink
105.0 x 148.0	<input type="checkbox"/> white		4					320	10773	✓	✓	
210.0 x 148.0	<input type="checkbox"/> white		2					160	10774	✓	✓	
210.0 x 297.0	<input type="checkbox"/> white ³⁾		1					80	10775	✓	✓	

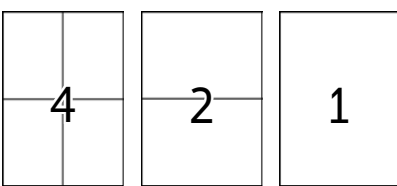

105.0 x 148.0 210.0 x 148.0 210.0 x 297.0



Processing information for labels: A few things to remember

- Store them at room temperature (about 20°C) and protect them from moisture
- If only part of the package contents are used, keep the remainder in the closed package (with climate protection)
- Thumb quickly through the sheets before putting them in the feed tray
- Allow sheets to pass through the printer only once. Sheets with missing labels can cause paper jams if sent through a second time
- Please follow the recommendations of the machine manufacturer for the processing of heavy or thick materials

³⁾ Peel-off aid on reverse (4 cuts)

Outdoor film labels

For rugged outdoor use.

When labels are used outdoors or for rugged applications, the material must be one hundred percent reliable. HERMA labels made of outdoor adhesive film with extra-strong adhesive prove what they're worth even in extreme conditions.

Suitable for all surfaces including metal and plastic and for critical substrates (rough, moist, cold, warm, dusty).

- Extremely strong adhesion, even on critical surfaces
- Weatherproof, age-resistant, oil and dirt repellent, wet-wipeable, resistant to temperatures between -40°C and +150°C, saltwater-resistant
- Stretch film: closely hugs any surface, even curved ones



Outdoor film labels

Polyethylene film, extra strong adhesion

Label format (mm)	Description	Features	Labels/ sheet	10 Sheets		40 Sheets		50 Sheets		Printer compatibility			
				Labels/ pack.	Ref. no.	Labels/ pack.	Ref. no.	Labels/ pack.	Ref. no.	Laser	Copy	Ink	Colour laser
45.7 x 21.2	<input type="checkbox"/> white, matt	<input checked="" type="checkbox"/>	48	480	9531	1920	9536			<input checked="" type="checkbox"/>	<input checked="" type="checkbox"/>	<input checked="" type="checkbox"/>	
63.5 x 33.9	<input type="checkbox"/> white, matt	<input checked="" type="checkbox"/>	24	240	9532	960	9537			<input checked="" type="checkbox"/>	<input checked="" type="checkbox"/>	<input checked="" type="checkbox"/>	
99.1 x 42.3	<input type="checkbox"/> white, matt	<input checked="" type="checkbox"/>	12	120	9533	480	9538			<input checked="" type="checkbox"/>	<input checked="" type="checkbox"/>	<input checked="" type="checkbox"/>	
99.1 x 139.0	<input type="checkbox"/> white, matt	<input checked="" type="checkbox"/>	4	40	9534	160	9539			<input checked="" type="checkbox"/>	<input checked="" type="checkbox"/>	<input checked="" type="checkbox"/>	
210.0 x 148.0	<input type="checkbox"/> white, matt		2	20	9535	80	9541			<input checked="" type="checkbox"/>	<input checked="" type="checkbox"/>	<input checked="" type="checkbox"/>	
210.0 x 297.0	<input type="checkbox"/> white, matt		1	10	9500	40	9543	50	9501	<input checked="" type="checkbox"/>	<input checked="" type="checkbox"/>	<input checked="" type="checkbox"/>	<input checked="" type="checkbox"/>
420.0 x 297.0	<input type="checkbox"/> white, matt, A3		1	10	9542	40	9544			<input checked="" type="checkbox"/>	<input checked="" type="checkbox"/>	<input checked="" type="checkbox"/>	<input checked="" type="checkbox"/>

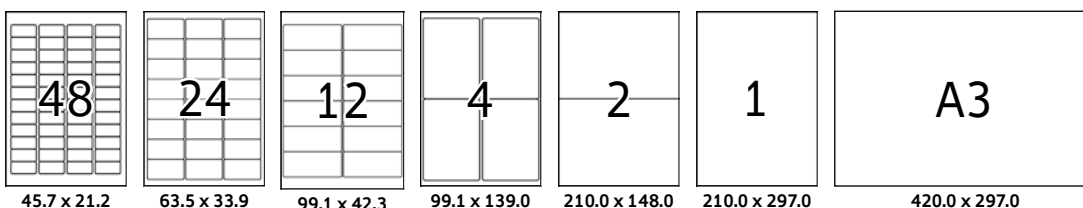

Discover outdoor film labels

[▶ Video](#)



It's all written on the back...

To aid in identification of sheets that have been taken from the package, the article number is shown on the back. This also ensures a correct match with the article number selected by the software. Printing errors can be reliably avoided. And when it's time to reorder, you'll know what to request, even if you have only one sheet left.

- Rounded corners
- Sheet with border on all sides

Weatherproof film labels

Strong performance even under tough conditions.

Water. oil. dirt. extreme temperatures – that’s no problem for these hard-wearing labels in white polyester film. Their weatherproof surface can withstand the harshest conditions. whether outdoors or indoors. wherever conventional paper labels are not up to the job. They have ultra-strong adhesion to any surface. Ideal for permanent property labelling, shelf labels in storage and production. signage. etc.

- Weatherproof. age-resistant. oil and dirt-repellent. tear-proof. wet-wipeable. resistant to temperatures between -30°C and +80°C. saltwater resistant
- Labelling of merchandise; identification labels. adhesive signs for display windows; information and warning signs; identification of items in storage and production facilities
- Weatherproof shipping labels: firm adhesion to all packaging materials: envelopes. parcels. shipping tubes. film. PE and Tyvek



Discover yellow film labels



Weatherproof film labels

Polyester film. extra strong adhesion		10 Sheets		25 Sheets		80 Sheets		Printer compatibility					
Label format (mm)	Description	Features	Labels/ sheet	Labels/ pack.	Ref. no.	Labels/ pack.	Ref. no.	Labels/ pack.	Ref. no.	Laser	Copy	Ink	Colour laser
37.0 x 13.0	white. matt ⁵⁾	☐	85			2125	8337			✓	✓	✓	
37.0 x 25.0	white. matt ⁵⁾	☐	50			1250	8338			✓	✓	✓	
45.7 x 21.2	yellow	☐	48			1200	8030			✓	✓	✓	
48.3 x 25.4	white. matt	☐	44	440	4581	1100	4690			✓	✓	✓	
63.5 x 29.6	yellow	☐	27			675	8031			✓	✓	✓	
66.0 x 33.8	white. matt ¹⁾	☐	24	240	4582	600	4691			✓	✓	✓	
70.0 x 37.0	white. matt ¹⁾	☐	24			600	4695			✓	✓	✓	
97.0 x 42.3	white. matt ²⁾	☐	12			300	4692			✓	✓	✓	
99.1 x 42.3	yellow	☐	12			300	8029			✓	✓	✓	
99.1 x 57.0	white. matt. e.g. shipping labels ²⁾	☐	10			250	8330			✓	✓	✓	
99.1 x 67.7	white. matt. e.g. shipping labels ²⁾	☐	8			200	8331			✓	✓	✓	
99.1 x 93.1	white. matt. e.g. shipping labels	☐	6			150	8332			✓	✓	✓	
105.0 x 148.0	white. matt. e.g. shipping labels ²⁾	☐	4	40	4583	100	4697			✓	✓	✓	
	yellow	☐	4			100	8032			✓	✓	✓	
190.0 x 135.0	white. matt. e.g. for signs ⁵⁾	☐	2			50	8333			✓	✓	✓	
190.0 x 275.0	white. matt. e.g. for signs ⁵⁾	☐	1			25	8334			✓	✓	✓	
210.0 x 148.0	white. matt	☐	2			50	4693			✓	✓	✓	
210.0 x 297.0	white. matt. e.g. for signs ⁴⁾	☐	1	10	4584	25	4698	80	10784	✓	✓	✓	
	yellow. e.g. for signs ⁴⁾	☐	1			25	8033			✓	✓	✓	
24.0 x 24.0	white. matt. square ⁵⁾	☐	70			1750	8339			✓	✓	✓	
∅ 30	yellow ⁵⁾	☐	48			1200	8034			✓	✓	✓	
∅ 85	white. matt ⁵⁾	☐	6			150	8336			✓	✓	✓	
	yellow ⁵⁾	☐	6			150	8035			✓	✓	✓	

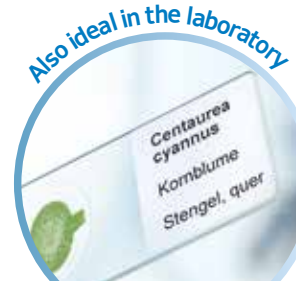

Weatherproof film labels. removable

Hard-wearing. durable and removable.

On shop windows, as information or warning signs, product identification or price labels: the hard-wearing film labels are strongly adhesive yet can be removed without leaving a trace. That makes them particularly suitable for temporary product labels or for frequently changing information in storage and production.

- Ideal for temporary product labels outdoors, as adhesive signs for shop windows, property labels, information and warning signs, and for changing information in storage and production
- Strong adhesion, yet removable without leaving traces of adhesive
- Weather-proof, age-resistant, oil and dirt-repellent, wet-wipeable, resistant to temperatures between -40°C and +60°C



Weatherproof film labels. removable

Polyester film. removable

Label format (mm)	Description	Features	Labels/ sheet	10 Sheets		20 Sheets		100 Sheets		Printer compatibility			
				Labels/ pack.	Ref. no.	Labels/ pack.	Ref. no.	Labels/ pack.	Ref. no.	Laser	Copy	Ink	Colour laser
48.3 x 25.4	<input type="checkbox"/> white, matt	<input type="checkbox"/>	44			880	4572			<input checked="" type="checkbox"/>	<input checked="" type="checkbox"/>	<input checked="" type="checkbox"/>	
66.0 x 33.8	<input type="checkbox"/> white, matt ¹⁾	<input type="checkbox"/>	24			480	4573			<input checked="" type="checkbox"/>	<input checked="" type="checkbox"/>	<input checked="" type="checkbox"/>	
97.0 x 42.3	<input type="checkbox"/> white, matt ²⁾	<input type="checkbox"/>	12			240	4574			<input checked="" type="checkbox"/>	<input checked="" type="checkbox"/>	<input checked="" type="checkbox"/>	
99.1 x 67.7	<input type="checkbox"/> white, matt ²⁾	<input checked="" type="checkbox"/>	8			160	4575			<input checked="" type="checkbox"/>	<input checked="" type="checkbox"/>	<input checked="" type="checkbox"/>	
105.0 x 148.0	<input type="checkbox"/> white, matt ²⁾		4			80	4576			<input checked="" type="checkbox"/>	<input checked="" type="checkbox"/>	<input checked="" type="checkbox"/>	
210.0 x 297.0	<input type="checkbox"/> white, matt ⁴⁾		1			20	4577			<input checked="" type="checkbox"/>	<input checked="" type="checkbox"/>	<input checked="" type="checkbox"/>	
∅ 30	<input type="checkbox"/> white, matt ⁵⁾	<input type="checkbox"/>	48			960	4571			<input checked="" type="checkbox"/>	<input checked="" type="checkbox"/>	<input checked="" type="checkbox"/>	

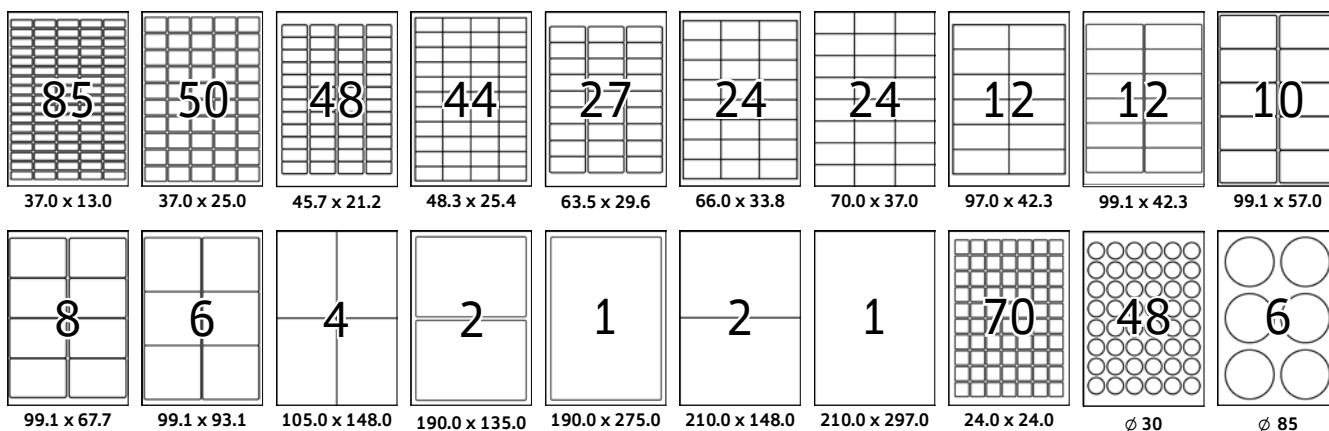

Ideal on glass panes

... and on display cases

- Rounded corners
- Sheet with border on all sides
- ⁴⁾ Peel-off aid on reverse (1 cut)
- ⁵⁾ Full-size printing (distance between the labels)

Suitable for INTERNETMARKE®:
¹⁾ without recipient's address
²⁾ with recipient's address

Rating plate labels

Label inventory and components permanently and dependably.

These silver labels are ideal for the permanent labelling of components and rating plates and for use in inventories. They have extra strong adhesion, even on critical surfaces. The matt foil is weatherproof and resistant to ageing. It repels oil and dirt, is wet-wipeable, and resistant to temperatures between -40°C and +150°C.

- Hard-wearing polyester film, extremely strong adhesion, even on critical surfaces
- High-quality stainless steel look
- Resistant to weather and ageing; oil and dirt-repellent, tear-resistant, wet-wipeable, resistant to temperatures between -40°C and +150°C



Rating plate labels

Polyester film, extra strong adhesion

Label format (mm)	Description	Features	Labels/ sheet	10 Sheets		25 Sheets		100 Sheets		Printer compatibility		
				Labels/ pack.	Ref. no.	Labels/ pack.	Ref. no.	Labels/ pack.	Ref. no.	Laser	Copy	Ink
25.4 x 10.0	silver, matt, opaque	☐	189			4725	4220			✓	✓	
45.7 x 21.2	silver, matt, opaque	☐	48			1200	4221			✓	✓	
63.5 x 29.6	silver, matt, opaque	☐	27	270	4592	675	4222			✓	✓	
96.0 x 50.8	silver, matt, opaque	☐	10			250	4223			✓	✓	
105.0 x 148.0	silver, matt, opaque		4			100	4216			✓	✓	
210.0 x 297.0	silver, matt, opaque ⁴⁾		1	10	4593	25	4224			✓	✓	

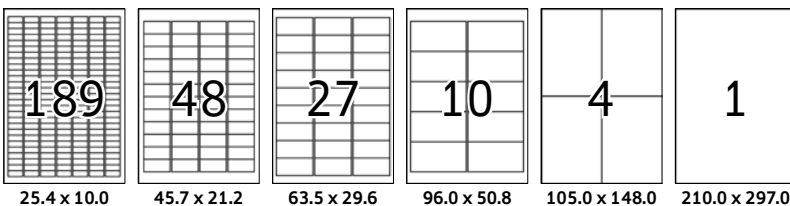

Decorative labels made of shiny silver foil can be found on page 51.



Label Assistant Online

- Free of charge, simple and fast:
- No programme download, no software installation
- Select format, design label individually, print PDF!
- Always up to date with all HERMA label formats

www.herma.com/lao

☐ Rounded corners
 ☐ Sheet with border on all sides
⁴⁾ Peel-off aid on reverse (1 cut)

Security/Seal labels

Absolutely tamper-proof.

Security/seal labels in white polyester film are ideal for guaranteed seal. When they are removed, a white grid pattern separates from the label. Once removed, the label can no longer be affixed in the original position or transferred to other objects. No manipulation attempt goes unnoticed. Ideal for inventory labels, for tamper-proof sealing of devices, data media, documents and switches, for labelling products and as test badges and guarantee seals.



Security labels

- Visible residue left behind when removed, providing security cannot be transferred to other objects
- Minimum adhesion time: 30 min. Unsuitable for materials that split easily (e.g. paper, cardboard etc.) and synthetic materials containing plasticizer

Seal labels

- Diverse range of applications as packaging or original seal, e.g. for bulk merchandise, mailings or documents
- Powerful adhesion, tear-resistant, resistant to temperatures between -30°C and +80°C

Security labels

Special film with anti-tamper facility, permanent adhesion

Label format (mm)	Description	Features	Labels/ sheet	10 Sheets		25 Sheets		100 Sheets		Printer compatibility		
				Labels/ pack.	Ref. no.	Labels/ pack.	Ref. no.	Labels/ pack.	Ref. no.	Laser	Copy	Ink
45.7 x 21.2	<input type="checkbox"/> white, special adhesive	<input checked="" type="checkbox"/>	48			1200	4232			<input checked="" type="checkbox"/>	<input checked="" type="checkbox"/>	
63.5 x 29.6	<input type="checkbox"/> white, special adhesive	<input checked="" type="checkbox"/>	27			675	4233			<input checked="" type="checkbox"/>	<input checked="" type="checkbox"/>	
∅ 40	<input type="checkbox"/> white, special adhesive ⁵⁾	<input type="checkbox"/>	24			600	4234			<input checked="" type="checkbox"/>	<input checked="" type="checkbox"/>	

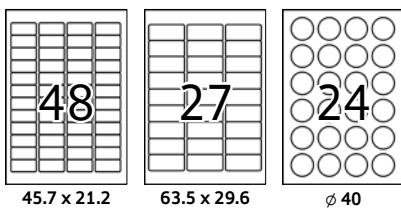

Testing recommended for substrates with poor adhesion (e.g. polypropylene)

Seal labels

Transparent polyester film, extra strong adhesion

Label format (mm)	Description	Features	Labels/ sheet	10 Sheets		25 Sheets		100 Sheets		Printer compatibility		
				Labels/ pack.	Ref. no.	Labels/ pack.	Ref. no.	Labels/ pack.	Ref. no.	Laser	Copy	Ink
∅ 40	transparent, matt ⁵⁾	<input type="checkbox"/>	24			600	4236			<input checked="" type="checkbox"/>	<input checked="" type="checkbox"/>	<input checked="" type="checkbox"/>

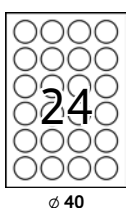

Remove with care to avoid damaging the subsurface



Transparent labels in many formats: page 50.

- Rounded corners
- Sheet with border on all sides
- ⁵⁾ Full-size printing (distance between the labels)

Transparent labels

Invisible yet effective.

Transparent labels from HERMA are virtually invisible – the inscription looks as if it is printed directly on the document. Ideal for coloured backgrounds and applications where visual appearance is important. for example coloured envelopes and folders as well as for inscriptions on stylish documents. for drawers and cabinets. for identifying documents. notices on desktop accessories. and for identifying property and products.

- Versatile: use wherever a white label would spoil the effect
- **Matt:** Ideal for coloured backgrounds. milky or satin glass or porcelain. stylish documents. updating or addressing
- **Crystal-clear:** glossy material. perfect on glass. shiny surfaces. plastic and metal
- Weather-resistant. oil and dirt-repellent. wet-wipeable. resistant to temperatures between -30°C and +80°C



Discover transparent labels



Transparent labels

Polyester film, permanent adhesion

Label format (mm)	Description	Features	Labels/ sheet	10 Sheets		25 Sheets		50/80 Sheets		Printer compatibility			
				Labels/ pack.	Ref. no.	Labels/ pack.	Ref. no.	Labels/ pack.	Ref. no.	Laser	Copy	Ink	Colour laser
45.7 x 21.2	crystal-clear, glossy	☐	48			1200	8016			✓	✓	✓	
48.3 x 25.4	matt	☐	44			1100	4680			✓	✓	✓	
52.5 x 29.7	matt		40			1000	4684			✓	✓	✓	
63.5 x 38.1	crystal-clear, glossy	☐	21			525	8017			✓	✓	✓	
63.5 x 38.1	matt	☐	21			525	8670			✓	✓	✓	
66.0 x 33.8	matt ^{1,1)}	☐	24			600	4681			✓	✓	✓	
70.0 x 37.0	matt		24			600	4685			✓	✓	✓	
96.0 x 50.8	crystal-clear, glossy	☐	10			200	8018			✓	✓	✓	
97.0 x 42.3	matt ²⁾	☐	12	120	4586	300	4682			✓	✓	✓	
99.1 x 38.1	matt	☐	14			350	8671			✓	✓	✓	
99.1 x 139.0	crystal-clear, glossy	☐	4			100	8019			✓	✓	✓	
210.0 x 148.0	matt ²⁾		2			50	4683			✓	✓	✓	
210.0 x 297.0	crystal-clear, glossy ⁴⁾		1			25	8020			✓	✓	✓	
210.0 x 297.0	matt ⁴⁾		1	10	4585	25	4375	100	10783	✓	✓	✓	
∅ 40	crystal-clear, glossy ⁵⁾	☐	24			600	8023			✓	✓	✓	
∅ 40	matt ⁵⁾	☐	24			600	4686			✓	✓	✓	
420.0 x 297.0	crystal-clear, glossy, A3		1					50	8694	✓	✓	✓	

48
45.7 x 21.2

44
48.3 x 25.4

40
52.5 x 29.7

21
63.5 x 38.1

24
66.0 x 33.8

24
70.0 x 37.0

10
96.0 x 50.8

12
97.0 x 42.3

14
99.1 x 38.1

4
99.1 x 139.0

2
210.0 x 148.0

1
210.0 x 297.0

24
∅ 40

A3
420.0 x 297.0

☐ Rounded corners

☐ Sheet with border on all sides

⁴⁾ Peel-off aid on reverse (1 cut)

⁵⁾ Full-size printing (distance between the labels)

Suitable for INTERNETMARKE®:

^{1,1)} optimized for printing with motif

²⁾ with recipient's address

Labels in silver film

Rise and shine! Refined and exclusive.

The decorative silver labels from HERMA give an especially elegant look to your brochures, catalogues, products and presentations. Because it's the little things that help your products stand out from the rest.



- High-quality labels with classy look thanks to gloss effect
- Ideal for applications where visual appearance is particularly important
- Reliable adhesion on all surfaces, adhesive is repositionable for a short period
- For anniversary and celebration labels, individual gifts, congratulations labels, punchy presentations, prestigious product stickers

Labels in silver film

Polyester film, glossy, permanent adhesion

Label format (mm)	Description	Features	Labels/ sheet	10 Sheets		25 Sheets		100 Sheets		Printer compatibility		
				Labels/ pack.	Ref. no.	Labels/ pack.	Ref. no.	Labels/ pack.	Ref. no.	Laser	Copy	Ink
30.5 x 16.9	silver, glossy	<input checked="" type="checkbox"/> <input type="checkbox"/>	96			2400	4110			<input checked="" type="checkbox"/>	<input checked="" type="checkbox"/>	<input checked="" type="checkbox"/>
45.7 x 21.2	silver, glossy	<input checked="" type="checkbox"/> <input type="checkbox"/>	48			1200	4097			<input checked="" type="checkbox"/>	<input checked="" type="checkbox"/>	<input checked="" type="checkbox"/>
63.5 x 29.6	silver, glossy	<input checked="" type="checkbox"/> <input type="checkbox"/>	27			675	4098			<input checked="" type="checkbox"/>	<input checked="" type="checkbox"/>	<input checked="" type="checkbox"/>
63.5 x 38.1	silver, glossy	<input checked="" type="checkbox"/> <input type="checkbox"/>	21			525	4113			<input checked="" type="checkbox"/>	<input checked="" type="checkbox"/>	<input checked="" type="checkbox"/>
96.0 x 50.8	silver, glossy	<input checked="" type="checkbox"/> <input type="checkbox"/>	10			250	4099			<input checked="" type="checkbox"/>	<input checked="" type="checkbox"/>	<input checked="" type="checkbox"/>
99.1 x 67.7	silver, glossy	<input checked="" type="checkbox"/> <input type="checkbox"/>	8			200	4114			<input checked="" type="checkbox"/>	<input checked="" type="checkbox"/>	<input checked="" type="checkbox"/>
210.0 x 297.0	silver, glossy ⁴⁾		1			25	4117			<input checked="" type="checkbox"/>	<input checked="" type="checkbox"/>	<input checked="" type="checkbox"/>
58.4 x 42.3	silver, glossy, oval ⁵⁾	<input type="checkbox"/>	18			450	4116			<input checked="" type="checkbox"/>	<input checked="" type="checkbox"/>	<input checked="" type="checkbox"/>

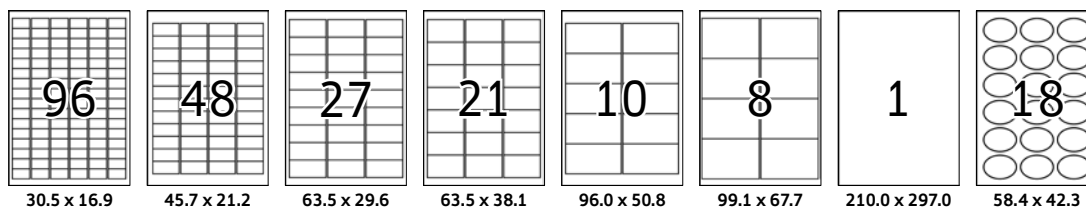

Silver cannot be shown with its original metallic sheen in the printed catalogue.

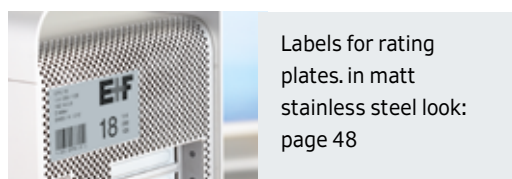

Labels for rating plates, in matt stainless steel look: page 48

- Rounded corners
- Sheet with border on all sides
- ⁴⁾ Peel-off aid on reverse (1 cut)
- ⁵⁾ Full-size printing (distance between the labels)

QR Code labels / Correction/covering labels

Excellently informed.

Label. inform. cross-reference: QR code labels are perfect for sticking on product packaging, catalogues and more. They are absolutely opaque, even on coloured backgrounds; nothing shines through. For optimal readability when scanned with a smartphone.



QR Code Labels

- Ideal for mobile tagging of URLs, telephone numbers, addresses and text
- Fully opaque, easily read by scanners

Correction/covering Labels

- Unwanted inscriptions are completely covered - fully opaque

Jewellery labels, special perforation

- Ideal for pricing rings, clocks, jewellery, glasses and small-diameter objects (e.g. cables)
- Simply loop the non-adhesive middle section around the object. After the backing paper has been removed from the middle section, the jewellery labels adhere over the whole surface

QR Code labels

Paper, permanent adhesion				10 Sheets	25 Sheets	100 Sheets	Printer compatibility						
Label format (mm)	Description	Features	Labels/ sheet	Labels/ pack.	Ref. no.	Labels/ pack.	Ref. no.	Labels/ pack.	Ref. no.	Laser	Copy	Ink	Colour laser
40.0 x 40.0	<input type="checkbox"/> white, opaque ⁵⁾	<input checked="" type="checkbox"/> F	24			600	9642			✓	✓	✓	✓
80.0 x 40.0	<input type="checkbox"/> white, opaque ⁵⁾	<input checked="" type="checkbox"/> F	12			300	9643			✓	✓	✓	✓

Correction/covering labels

Paper, permanent adhesion				10 Sheets	25 Sheets	100 Sheets	Printer compatibility						
Label format (mm)	Description	Features	Labels/ sheet	Labels/ pack.	Ref. no.	Labels/ pack.	Ref. no.	Labels/ pack.	Ref. no.	Laser	Copy	Ink	Colour laser
48.3 x 16.9	<input type="checkbox"/> white, opaque	<input type="checkbox"/> F	464			1600	4226			✓	✓	✓	✓
64.6 x 33.8	<input type="checkbox"/> white, opaque	<input type="checkbox"/> F	24			600	4227			✓	✓	✓	✓
97.0 x 42.3	<input type="checkbox"/> white, opaque ²⁾	<input type="checkbox"/> F	12			300	4228			✓	✓	✓	✓
105.0 x 148.0	<input type="checkbox"/> white, opaque ²⁾	F	4			100	4229			✓	✓	✓	✓
210.0 x 297.0	<input type="checkbox"/> white, opaque ³⁾	F	1			25	4230			✓	✓	✓	✓

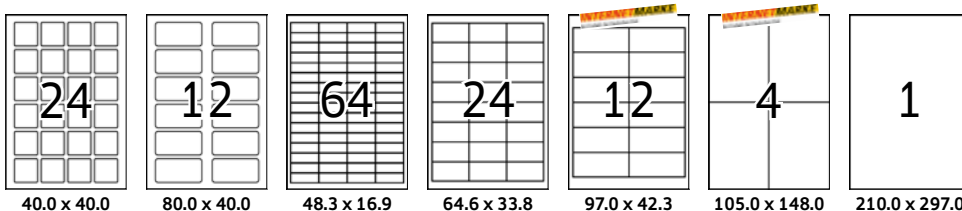

Jewellery labels

Paper, permanent adhesion				10 Sheets	25 Sheets	100 Sheets	Printer compatibility						
Label format (mm)	Description	Features	Labels/ sheet	Labels/ pack.	Ref. no.	Labels/ pack.	Ref. no.	Labels/ pack.	Ref. no.	Laser	Copy	Ink	Colour laser
49.0 x 10.0	<input type="checkbox"/> white, opaque ⁵⁾	<input type="checkbox"/> F	60			1500	5116			✓	✓	✓	✓

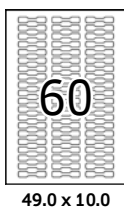

Simply loop the non-adhesive middle section around the object and press the adhesive surfaces together – done.

- Rounded corners
- Sheet with border on all sides
- F** FSC™-certified label material from responsibly managed forests
- ³⁾ Peel-off aid on reverse (4 cuts)
- ⁵⁾ Full-size printing (distance between the labels)

Deep-freeze labels / Labels for shipping or warning notes

Guaranteed freezer-proof.

Ideal labels for product labelling on frozen food packaging or for content and shelf life information in the freezer. Even on slightly icy or slightly moist surfaces, the adhesion of the adhesive is high.



Deep-freeze labels

- Adhere firmly and permanently even to packs which are already frozen
- Minimum adhesive temperature: -25°C. resistant to temperatures between -60°C and +60°C

Labels for shipping or warning notes

- Special attention for special instructions

Shipping label + delivery note. for online franking

- Print shipping labels and bills of lading, invoices or advance shipping notices in a single print run
- Especially suitable for online franking

Deep-freeze labels

Paper, deep-freeze adhesive

Label format (mm)	Description	Features	Labels/ sheet	10 Sheets		25 Sheets		100 Sheets		Printer compatibility			
				Labels/ pack.	Ref. no.	Labels/ pack.	Ref. no.	Labels/ pack.	Ref. no.	Laser	Copy	Ink	Colour laser
38.1 x 21.2	<input type="checkbox"/> white	<input type="checkbox"/> F	65			1625	4388			✓	✓	✓	✓
66.0 x 33.8	<input type="checkbox"/> white	<input type="checkbox"/> F	24			600	4389			✓	✓	✓	✓

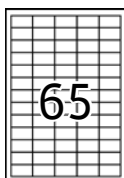

38.1 x 21.2

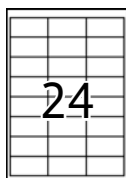

66.0 x 33.8

Labels for shipping or warning notes. shipping label + delivery note

Paper, permanent adhesion

Label format (mm)	Description	Features	Labels/ sheet	10 Sheets		20/25 Sheets		100 Sheets		Printer compatibility			
				Labels/ pack.	Ref. no.	Labels/ pack.	Ref. no.	Labels/ pack.	Ref. no.	Laser	Copy	Ink	Colour laser
50.0 x 142.0	<input type="checkbox"/> white	<input checked="" type="checkbox"/> F	8			200	8326			✓	✓	✓	✓
99.1 x 67.7	<input checked="" type="checkbox"/> neon red ²⁾	<input checked="" type="checkbox"/> F	8			160	5046			✓	✓	✓	✓
99.1 x 67.7	<input type="checkbox"/> white ²⁾	<input checked="" type="checkbox"/> F	8			200	5077	800	4269	✓	✓	✓	✓
Shipping label + delivery note. can be torn off thanks to microperforations. permanent adhesion													
182.0 x 130.0	<input type="checkbox"/> white, opaque, perforated	<input checked="" type="checkbox"/> F	1			25	8316			✓	✓	✓	✓

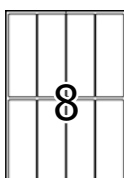

50.0 x 142.0

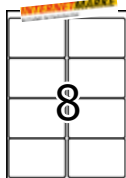

99.1 x 67.7

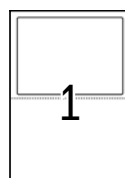

182.0 x 130.0



- Rounded corners
- Sheet with border on all sides
- F** FSC™-certified label material from responsibly managed forests

Suitable for INTERNETMARKE®:
²⁾ with recipient's address

Product and price labelling

Robust and easy to detach.

Tags make great product and price labels. They are made of robust material. are printable on both sides. quick and simple to detach thanks to the microperforations.

- product and price labels on textiles
- as shipping tags on security tape and lattice box pallets
- for indicating material flows (tags accompanying merchandise)
- on pipes, wire, profiled sections, coils or spools or for the marking of large containers and workpieces



Robust tags

- Made of robust paper/film/paper laminate
- With pre-cut hole; simple to attach with a tagging gun or with strings and barbs

Labels, perforated, with adhesive strip on back

- Can be used as fully-adhesive label or as a tag with the adhesive strip on the rear
- Ideal in situations where full-surface application of the label is not required

Robust tags

Paper/film/paper, fast to detach thanks to microperforations

Label format (mm)	Description	Features	Labels/ sheet	10 Sheets		25 Sheets		100 Sheets		Printer compatibility			
				Labels/ pack.	Ref. no.	Labels/ pack.	Ref. no.	Labels/ pack.	Ref. no.	Laser	Copy	Ink	Colour laser
30.0 x 37.0	<input type="checkbox"/> white, tear-resistant		56					5600	8044	✓	✓	✓	✓
35.0 x 59.4	<input type="checkbox"/> white, tear-resistant		30					3000	8046	✓	✓	✓	✓
42.0 x 70.0	<input type="checkbox"/> white, tear-resistant		20					2000	6871	✓	✓	✓	✓
52.5 x 93.5	<input type="checkbox"/> white, tear-resistant		12					1200	6872	✓	✓	✓	✓
70.0 x 148.5	<input type="checkbox"/> white, tear-resistant		6					600	8047	✓	✓	✓	✓

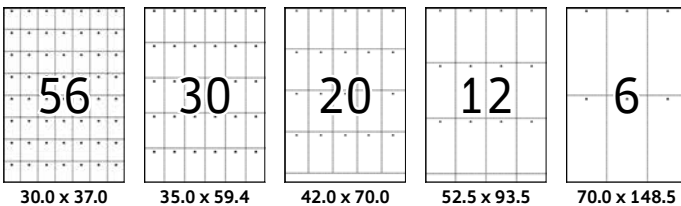

Ideal as a colli trailer on securing straps and lattice boxes.

Labels, perforated, with adhesive strip on back

Paper, perforated, permanent adhesion

Label format (mm)	Description	Features	Labels/ sheet	10 Sheets		25 Sheets		100 Sheets		Printer compatibility			
				Labels/ pack.	Ref. no.	Labels/ pack.	Ref. no.	Labels/ pack.	Ref. no.	Laser	Copy	Ink	Colour laser
210.0 x 99.0	<input type="checkbox"/> white, perforated	F	3					300	4664	✓	✓	✓	✓

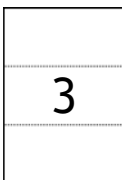

210.0 x 99.0



Label or tag – depending on requirements.

Can be used as fully-adhesive label or as a tag with the adhesive strip on the rear. Fast and easy to detach thanks to microperforations.

Labels for the Home & Office (packs of 5 and 10 sheets)

Ideal for home & office work.

Labels in small, practical 10-sheet packs. Private individuals, small business operators, law firms and doctors' surgeries also need only a few label sheets for special label solutions. Best quality, in practical small quantities. For laser printers, colour laser printers, inkjet printers and copiers/colour copiers. And of course can also be labelled by hand.



- PREMIUM labels in packs of 10 sheets. permanently adhesive, guaranteed jam-free, high whiteness
- Removable labels for general use in packs of 5 sheets, removable without residue + adhering again several times
- Opaque file spine labels for narrow or wide folders, secure adhesion even with frequent folder use
- CD labels with positioning aid on each label, secure adhesion even in high-speed drives
- Name labels made of acetate silk, secure adhesion, removable without leaving residues

Labels for home & office (5 and 10 sheets)

Paper, permanent adhesion (HERMA PREMIUM labels)

Label format (mm)	Description	Features	5 Sheets		10 Sheets		Printer compatibility			
			Labels/ sheet	Labels/ pack. Ref. no.	Labels/ pack. Ref. no.	Laser	Copy	Ink	Colour laser	
38.1 x 21.2	<input type="checkbox"/> white	<input type="checkbox"/> F	65		650	8629	✓	✓	✓	✓
48.3 x 33.8	<input type="checkbox"/> white	<input type="checkbox"/> F	32		320	8643	✓	✓	✓	✓
63.5 x 38.1	<input type="checkbox"/> white, ideal for C6 envelope	<input checked="" type="checkbox"/> F	21		210	8632	✓	✓	✓	✓
66.0 x 33.8	<input type="checkbox"/> white ^{1.1)}	<input type="checkbox"/> F	24		240	8633	✓	✓	✓	✓
70.0 x 36.0	<input type="checkbox"/> white ^{1.1)}	<input type="checkbox"/> F	24		240	8638	✓	✓	✓	✓
70.0 x 37.0	<input type="checkbox"/> white	<input type="checkbox"/> F	24		240	8644	✓	✓	✓	✓
70.0 x 42.3	<input type="checkbox"/> white ^{1.1)}	<input type="checkbox"/> F	21		210	8634	✓	✓	✓	✓
97.0 x 42.3	<input type="checkbox"/> white ²⁾	<input type="checkbox"/> F	12		120	8628	✓	✓	✓	✓
99.1 x 38.1	<input type="checkbox"/> white, ideal for DL envelope	<input checked="" type="checkbox"/> F	14		140	8635	✓	✓	✓	✓
105.0 x 74.0	<input type="checkbox"/> white ²⁾	<input type="checkbox"/> F	8		80	8645	✓	✓	✓	✓
105.0 x 148.0	<input type="checkbox"/> white ²⁾	<input type="checkbox"/> F	4		40	8630	✓	✓	✓	✓
210.0 x 148.0	<input type="checkbox"/> white	<input type="checkbox"/> F	2		20	8636	✓	✓	✓	✓
210.0 x 297.0	<input type="checkbox"/> white ³⁾	<input type="checkbox"/> F	1		10	8637	✓	✓	✓	✓
Special shape labels										
∅ 35	<input type="checkbox"/> white, heart-shaped	<input type="checkbox"/> F	35		350	10790	✓	✓	✓	✓
∅ 60	<input type="checkbox"/> white, heart-shaped ²⁾	<input type="checkbox"/> F	12		120	10791	✓	✓	✓	✓

Removable labels for general use, paper, removable without residue + adhering again several times

63.5 x 38.1	<input type="checkbox"/> white, removable without residue	<input checked="" type="checkbox"/> F	21	105	12902		✓	✓	✓	✓
-------------	---	---------------------------------------	----	-----	-------	--	---	---	---	---



Label Assistant Online

- Free of charge, simple and fast:
- No programme download, no software installation
- Select format, design label individually, print PDF!
- Always up to date with all HERMA label formats

www.herma.co.uk/lao

Rounded corners

Sheet with border on all sides

FSC™-certified label material from responsibly managed forests

³⁾ Peel-off aid on reverse (4 cuts)

⁵⁾ Full-size printing (distance between the labels)

Suitable for INTERNETMARKE®:

^{1.1)} optimized for printing with motif

²⁾ with recipient's address

Labels for the Home & Office (packs of 5 and 10 sheets)

Special labels (5 and 10 sheets)

File spine labels, paper, opaque

Label format (mm)	Description	Features	Labels/ sheet	5 Sheets		10 Sheets		Printer compatibility			
				Labels/ pack.	Ref. no.	Labels/ pack.	Ref. no.	Laser	Copy	Ink	Colour laser
192.0 x 38.0	<input type="checkbox"/> white, narrow, short, removable	<input checked="" type="checkbox"/> F	7	35	12900			✓	✓	✓	✓
192.0 x 38.0	<input type="checkbox"/> white, narrow, short	<input checked="" type="checkbox"/> F	7			70	8620	✓	✓	✓	✓
192.0 x 61.0	<input type="checkbox"/> white, wide, short, removable	<input checked="" type="checkbox"/> F	4	20	12901			✓	✓	✓	✓
192.0 x 61.0	<input type="checkbox"/> white, wide, short	<input checked="" type="checkbox"/> F	4			40	8621	✓	✓	✓	✓

CD labels, paper, opaque, permanent adhesion

∅ 116 Maxi	<input type="checkbox"/> white, opaque, hole diameter : 18.5 mm	<input type="checkbox"/> F	2			20	8624	✓	✓	✓	✓
∅ 78	<input type="checkbox"/> white, opaque, Mini-CD 8 cm, hole diameter : 18.5 mm	<input type="checkbox"/> F	6			60	8619	✓	✓	✓	✓

Inkjet CD labels, glossy, permanent adhesion

∅ 116 Maxi	<input type="checkbox"/> white, glossy, hole diameter : 18.5 mm	<input type="checkbox"/>	2			20	8885				✓
------------	---	--------------------------	---	--	--	----	------	--	--	--	---

Name/textile labels, acetate silk, removable

80.0 x 50.0	<input type="checkbox"/> white, individually separable ⁵⁾	<input checked="" type="checkbox"/>	10			100	4587	✓	✓		✓
88.9 x 33.8	<input type="checkbox"/> white	<input checked="" type="checkbox"/>	16			160	4588	✓	✓		✓

Inkjet glossy labels, glossy paper, permanent adhesion

210.0 x 297.0	<input type="checkbox"/> white, glossy ⁴⁾			1		10	8895				✓
90.0 x 120.0	<input type="checkbox"/> white, glossy, bottle labels ⁵⁾	<input type="checkbox"/>		4		40	8882				✓



Folder labels

PC printable. 100% opaque. Securely adhesive for frequent folder use.

For details and other versions see page 24-27.



CD labels

100% opaque, securely adheres even in high-speed drives. Positioning aid on each label. Maxi format: plenty of space for text & image (hole ∅ 18.5 mm).

Details see page 28.



Name/textile labels

Flexible textile material - securely adhesive, easy to remove. Ideal as name label and for labelling fabrics, carpets, mattresses.

Details see page 42.



Bottle labels

Ideal for high-quality colour-intensive labels for bottles, gifts from the kitchen and much more. Inkjet glossy paper, instant dry, very smudge resistant.

Details see page 39.

Grid of label templates with dimensions and counts:

- 38.1 x 21.2 (65)
- 48.3 x 33.8 (32)
- 63.5 x 38.1 (21)
- 66.0 x 33.8 (24)
- 70.0 x 36.0 (24)
- 70.0 x 37.0 (24)
- 70.0 x 42.3 (21)
- 97.0 x 42.3 (12)
- 99.1 x 38.1 (14)
- 99.1 x 139.0 (4)
- 105.0 x 74.0 (8)
- 105.0 x 148.0 (4)
- 210.0 x 148.0 (2)
- 210.0 x 297.0 (1)
- ∅ 35 (35)
- ∅ 60 (12)
- 192.0 x 38.0 (7)
- 192.0 x 61.0 (4)
- ∅ 116 Maxi (2)
- ∅ 78 (6)
- 80.0 x 50.0 (10)
- 88.9 x 33.8 (16)
- 90.0 x 120.0 (4)

Special labels (10 sheets)

Transparent labels. polyester film. permanent adhesion

Label format (mm)	Description	Features	Labels/ sheet	5 Sheets		10 Sheets		Printer compatibility			
				Labels/ pack.	Ref. no.	Labels/ pack.	Ref. no.	Laser	Copy	Ink	Colour laser
97.0 x 42.3	transparent	<input type="checkbox"/>	12			120	4586	<input checked="" type="checkbox"/>	<input checked="" type="checkbox"/>	<input checked="" type="checkbox"/>	
210.0 x 297.0	transparent	<input type="checkbox"/>	1			10	4585	<input checked="" type="checkbox"/>	<input checked="" type="checkbox"/>	<input checked="" type="checkbox"/>	

Rating plate labels. polyester film. extremely strong adhesion

63.5 x 29.6	<input type="checkbox"/> silver. matt. opaque	<input checked="" type="checkbox"/>	27			270	4592	<input checked="" type="checkbox"/>	<input checked="" type="checkbox"/>		
210.0 x 297.0	<input type="checkbox"/> silver. matt. opaque ⁴⁾	<input type="checkbox"/>	1			10	4593	<input checked="" type="checkbox"/>	<input checked="" type="checkbox"/>		



Transparent labels

The inscription looks as if it has been printed directly onto the label. Ideal on coloured backgrounds and for visually demanding applications.

For details see page 50.



Rating plate labels

Durable film. extremely strong adhesion even on critical surfaces. High-quality stainless steel look. Weatherproof and dirt repellent.

Details see page 48.

Outdoor film labels. polyethylene film. extremely strong adhesion

45.7 x 21.2	<input type="checkbox"/> white. matt	<input checked="" type="checkbox"/>	48			480	9531	<input checked="" type="checkbox"/>	<input checked="" type="checkbox"/>	<input checked="" type="checkbox"/>	
63.5 x 33.9	<input type="checkbox"/> white. matt	<input checked="" type="checkbox"/>	24			240	9532	<input checked="" type="checkbox"/>	<input checked="" type="checkbox"/>	<input checked="" type="checkbox"/>	
99.1 x 42.3	<input type="checkbox"/> white. matt	<input checked="" type="checkbox"/>	12			120	9533	<input checked="" type="checkbox"/>	<input checked="" type="checkbox"/>	<input checked="" type="checkbox"/>	
99.1 x 139.0	<input type="checkbox"/> white. matt	<input checked="" type="checkbox"/>	4			40	9534	<input checked="" type="checkbox"/>	<input checked="" type="checkbox"/>	<input checked="" type="checkbox"/>	
210.0 x 148.0	<input type="checkbox"/> white. matt	<input type="checkbox"/>	2			20	9535	<input checked="" type="checkbox"/>	<input checked="" type="checkbox"/>	<input checked="" type="checkbox"/>	
210.0 x 297.0	<input type="checkbox"/> white. matt	<input type="checkbox"/>	2			10	9500	<input checked="" type="checkbox"/>	<input checked="" type="checkbox"/>	<input checked="" type="checkbox"/>	
297.0 x 420.0	<input type="checkbox"/> A3. white. matt	<input type="checkbox"/>	1			10	9542	<input checked="" type="checkbox"/>	<input checked="" type="checkbox"/>	<input checked="" type="checkbox"/>	

Weatherproof film labels. polyester film. extremely strong adhesion

48.3 x 25.4	<input type="checkbox"/> white. matt	<input type="checkbox"/>	44			440	4581	<input checked="" type="checkbox"/>	<input checked="" type="checkbox"/>	<input checked="" type="checkbox"/>	
66.0 x 33.8	<input type="checkbox"/> white. matt	<input type="checkbox"/>	24			240	4582	<input checked="" type="checkbox"/>	<input checked="" type="checkbox"/>	<input checked="" type="checkbox"/>	
105.0 x 148.0	<input type="checkbox"/> white. matt	<input type="checkbox"/>	4			40	4583	<input checked="" type="checkbox"/>	<input checked="" type="checkbox"/>	<input checked="" type="checkbox"/>	
210.0 x 297.0	<input type="checkbox"/> white. matt ⁴⁾	<input type="checkbox"/>	1			10	4584	<input checked="" type="checkbox"/>	<input checked="" type="checkbox"/>	<input checked="" type="checkbox"/>	

Weatherproof inkjet film labels. polypropylene. permanent adhesion

63.5 x 33.9	<input type="checkbox"/> white. matt	<input checked="" type="checkbox"/>	27			270	4864	<input checked="" type="checkbox"/>			
97.0 x 42.3	<input type="checkbox"/> white. matt	<input type="checkbox"/>	12			120	4595	<input checked="" type="checkbox"/>			
105.0 x 148.0	<input type="checkbox"/> white. matt	<input type="checkbox"/>	4			40	4598	<input checked="" type="checkbox"/>			
210.0 x 148.0	<input type="checkbox"/> white. matt	<input type="checkbox"/>	2			20	4600	<input checked="" type="checkbox"/>			
210.0 x 297.0	<input type="checkbox"/> white. matt ⁴⁾	<input type="checkbox"/>	1			10	4866	<input checked="" type="checkbox"/>			
210.0 x 297.0	transparent. crystal-clear ⁴⁾	<input type="checkbox"/>	1			10	8964	<input checked="" type="checkbox"/>			



Outdoor film labels

Extremely strong adhesion. even on critical surfaces. Weatherproof. temperature-resistant. Stretchable. also suitable for curved surfaces.

Details see page 45.



Weatherproof film labels

Permanently adhesive or removable. Ideal for property labels. shop window stickers. information and warning signs. for heavy-duty markings.

Details see page 46.

45.7 x 21.2	48.3 x 25.4	63.5 x 29.6	63.5 x 33.9	66.0 x 33.8	97.0 x 42.3	99.1 x 42.3	99.1 x 139.0	105.0 x 148.0	210 x 148.0

210.0 x 297.0	420.0 x 297.0

Rounded corners

Sheet with border on all sides

F FSC™-certified label material from responsibly managed forests

⁴⁾ Peel-off aid on reverse (1 cut)

Hygiene range

Best by far.

Communicating distance rules, reminding people to wash their hands – with the right labels, this can be done cleanly and effectively. The HERMA hygiene range offers the right solution for the most important situations – easy to apply and securely adhering.

- Durable, weatherproof polyester film
- Removable if required
- Poster-like and easy to understand
- Securely adheres to smooth and clean floors and clean floors, doors, shop windows, in sanitary cabinets and walls
- For use in shops, hotel, restaurant, in companies, public facilities, doctors' surgeries, etc.
- As long as stock lasts



Information sticker

Polyester film, printed, removable

5 Sheets

Label format (mm)	Description	Labels/ Sheets	Labels/ pack.	Ref. no.
Notes on floor markings				
70.0 x 297.0	Text and pictograms "Keep your distance"	3	15	12918
	Pictograms "Keep your distance"	3	15	12919
	Neutral	3	15	12920
Mandatory signs and information labels				
ø 200	Text and pictograms "Keep your distance"	1	5	12921
	Pictograms "Keep your distance"	1	5	12922
	Pictogram "Use protective mask"	1	5	12923
ø 100	Text and pictograms "Keep your distance"	4	20	12924
	Pictograms "Keep your distance"	4	20	12925
	Pictogram "Handshake prohibited"	4	20	12926
	Pictogram "Wash hands"	4	20	12927
	Pictogram "Disinfect hands"	4	20	12928
	Pictogram "Use protective mask"	4	20	12929



12921
12924

12922
12925



12923
12929

12926



12927

12928



12918

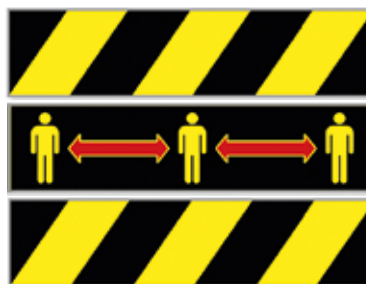

12919



12920

89,1 cm / 35,03 inch

7 cm / 2,76 inch



7 cm / 2,76 inch

Multi-purpose labels for hand lettering

Quickly make themselves indispensable.

They are practical aids for all kinds of everyday tasks: calling attention to important information, labelling, organizing, scheduling and planning. Ideal for fast hand labelling.

- Permanent adhesive or removable without residue & adhering again several times
- Available in white and many colours
- Also available as marking/moderation dots, jewellery labels or sealing labels
- Not suitable for PC printers

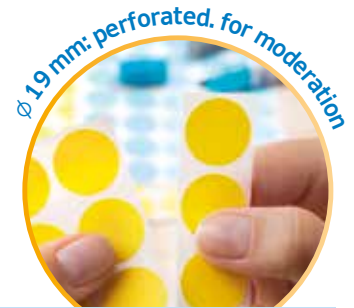

Colour dots, permanent adhesion

Papier			Small packs			Office packs		
Label format (mm)	Description	Features	Labels/ Sheets	Labels/ pack.	Ref. no.	Labels/ Sheets	Labels/ pack.	Ref. no.
ø 8	White	F	108	540	1840	176	5632	2210
	Yellow	F	108	540	1841	176	5632	2211
	Orange	F	108	540	1842	176	5632	2212
	Pink	F	108	540	1836			
	Light Blue	F	108	540	1843	176	5632	2213
	Dark Blue	F	108	540	1833			
	Green	F	108	540	1845	176	5632	2215
	Dark Green	F	108	540	1835			
	Grey	F	108	540	1838			
	Black	F	108	540	1849			
	Yellow-Orange	F	108	540	1834			
	Orange-Pink	F	108	540	1844			
	Pink-Green	F	108	540	1846			
	Green-White	F	108	540	1848			
	ø 13	White	F	48	240	1860	77	2464
Yellow		F	48	240	1861	77	2464	2231
Orange		F	48	240	1862	77	2464	2232
Pink		F	48	240	1856			
Light Blue		F	48	240	1863	77	2464	2233
Dark Blue		F	48	240	1853			
Green		F	48	240	1865	77	2464	2235
Dark Green		F	48	240	1855			
Grey		F	48	240	1858			
Black		F	48	240	1869			
Yellow-Orange		F	48	240	1854			
Orange-Pink		F	48	240	1864	77	1848	2234
Pink-Green		F	48	240	1866	77	1848	2236
Green-White		F	48	240	1868			
ø 16		White	F				54	1728

Neon colours cannot be shown with their original intensity in the printed catalogue.

Papier			Small packs			Office packs			
Label format (mm)	Description	Features	Labels/ sheet	Labels/ pack.	Ref. no.	Labels/ sheet	Labels/ pack.	Ref. no.	
ø 19	White	F	20	100	1870	40	1280	2250 *	
	Yellow	F	20	100	1871	40	1280	2251 *	
	Orange	F	20	100	1872	40	1280	2252 *	
	Pink	F	20	100	1886				
	Light Blue	F	20	100	1873	40	1280	2253 *	
	Dark Blue	F	20	100	1883				
	Green	F	20	100	1875	40	1280	2255 *	
	Dark Green	F	20	100	1885				
	Grey	F	20	100	1888				
	Black	F	20	100	1879				
	Yellow-Orange	F	20	100	1884				
	Orange-Pink	F	20	100	1874	40	960	2254 *	
	Pink-Green	F	20	100	1876	40	960	2256 *	
	Green-White	F	20	100	1878				
	ø 25	White	F				24	768	2260
Yellow		F				15	480	2270	
Orange		F				15	480	2271	
Pink		F				15	480	2272	
Light Blue		F				15	480	2273	
Dark Blue		F				15	480	2275	
Green		F				15	360	2274	
Dark Green		F				15	360	2276	
Grey		F		6	18 15074				
Black		F		6	18 15075				
ø 50		White	F				6	192	2280
		Yellow-Orange	F				6	144	2284
		Pink-Green	F				6	144	2286

* Detachable strips, each with 8 colour dots.

F FSC™-certified label material from responsibly managed forests

Multi-purpose labels for hand lettering

Multi-purpose labels. permanent adhesion

Papier			Small packs			Office packs		
Label format (mm)	Description	Features	Labels/ sheet	Labels/ pack.	Ref. no.	Labels/ sheet	Labels/ pack.	Ref. no.
5 x 35	□	F	36	252	3735 ¹⁾	60	1920	2300
6 x 50	□	F				39	1248	2530
8 x 12	□	F	66	462	3610	120	3840	2310
8 x 20	□	F	35	280	3721	70	2240	2320
8 x 36	□	F	24	168	3724 ²⁾			
10 x 16	□	F				81	2592	2330
12 x 18	□	F	32	224	3640	56	1792	2340
	■	F	32	160	3641	56	1792	2341
	■	F	32	160	3642	56	1792	2342
	■	F	32	160	3643	56	1792	2343
	■	F	32	160	3645	56	1792	2345
12 x 30	□	F				35	1120	2350
	■	F				35	1120	2351
	■	F				35	1120	2352
	■	F				35	1120	2353
	■	F				35	1120	2355
12 x 34	□	F	18	126	3650			
	■	F	18	90	3651			
	■	F	18	90	3652			
	■	F	18	90	3653			
	■	F	18	90	3655			
13 x 40	□	F	16	112	3739	28	896	2360
	■	F				28	896	2361
	■	F				28	896	2362
	■	F				28	896	2363
	■	F				28	896	2365
13 x 50	□	F	10	70	3737	21	672	2370
15 x 20	□	F	25	175	3660			
	■	F	25	125	3661			
	■	F	15	125	3662			
16 x 22	□	F				42	1344	2380
	■	F				42	1344	2381 ³⁾
	■	F				42	1344	2382 ³⁾
	■	F				42	1344	2383 ³⁾
17 x 26	□	F	18	126	3746			
19 x 27	□	F				30	960	2390
19 x 40	□	F	10	70	3738	20	640	2400
20 x 50	□	F	8	56	3749	15	480	2410
	■	F				15	480	2411
	■	F				15	480	2412
	■	F				15	480	2413
	■	F				15	480	2415
	■	F				15	360	2414
	■	F				15	360	2416

Papier			Small packs			Office packs		
Label format (mm)	Description	Features	Labels/ sheet	Labels/ pack.	Ref. no.	Labels/ sheet	Labels/ pack.	Ref. no.
20 x 75	□	F				10	320	2420
	■	F				10	320	2421 ³⁾
	■	F				10	320	2422 ³⁾
21 x 82	□	F	5	35	3750			
22 x 32	□	F				29	640	2430
24 x 24	□	F				24	768	2460
24 x 35	□	F	9	63	3752			
25 x 40	□	F	8	56	3690	16	512	2450
	■	F	8	40	3691	16	512	2451
	■	F	8	40	3692	16	512	2452
	■	F	8	40	3693	16	512	2453
	■	F	8	40	3695	16	512	2455
26 x 54	□	F	6	42	3754			
	■	F	6	42	15076			
	■	F	6	42	15077			
31 x 100	□	F				5	160	2550
32 x 41	□	F				12	384	2440
32 x 82	□	F				6	192	2540
34 x 53	□	F				9	288	2470
	■	F				9	288	2471 ³⁾
	■	F				9	288	2472 ³⁾
	■	F				9	288	2473 ³⁾
	■	F				9	288	2475 ³⁾
34 x 67	□	F	3	21	3757	6	192	2480
	■	F	3	21	15078			
	■	F	3	21	15079			
	■	F	6	42	3753			
36 x 40	□	F	3	21	3756			
39 x 50	□	F				8	256	2560
40 x 55	□	F	4	28	3755			
40 x 75	□	F				6	192	2590
50 x 75	□	F				4	128	2516 ³⁾
52 x 82	□	F				4	128	2490
	■	F				4	128	2491
	■	F				4	128	2492
	■	F				4	128	2493
	■	F				4	128	2495
52 x 100	□	F				3	96	2500
55 x 82	□	F	2	14	3758			
74 x 105	□	F				2	64	2570
81 x 110	□	F	1	8	3759			
100 x 149	□	F				1	32	2580

Neon colours cannot be shown with their original intensity in the printed catalogue.

	white		blue		grey		neon red
	yellow		dark blue		black		neon green
	red		green		neon yellow		gold
	pink		dark green		neon orange		silver

¹⁾ white. inscription strips

²⁾ for slides

³⁾ available as long as in stock

F FSC™-certified label material from responsibly managed forests

Removable multi-purpose labels

Paper, without residue + adhering again several times			Office packs		
Label format (mm)	Description	Features	Labels/ sheet	Labels/ pack.	Ref. no.
8 x 12	<input type="checkbox"/>	F	120	3840	10600
12 x 18	<input type="checkbox"/>	F	56	1792	10603
13 x 40	<input type="checkbox"/>	F	28	896	10605
13 x 50	<input type="checkbox"/>	F	21	672	10606
19 x 27	<input type="checkbox"/>	F	30	960	10608
19 x 40	<input type="checkbox"/>	F	20	640	10609
20 x 50	<input type="checkbox"/>	F	15	480	10610
25 x 40	<input type="checkbox"/>	F	16	512	10613
34 x 67	<input type="checkbox"/>	F	6	192	10616
52 x 82	<input type="checkbox"/>	F	4	128	10618



Multi-purpose labels, permanent, assortments

Paper, permanent adhesion			Office packs		
Label format (mm)	Description	Features	Labels/ sheet	Labels/ pack.	Ref. no.
∅ 8		F	108	540	1831
∅ 13		F	48	240	1851
∅ 19		F	20	100	1881
12 x 19		F	32	160	3631
26 x 40		F	8	40	3681

- Various colours and sizes on one sheet
- In small packs, sheet format 84 x 120 mm

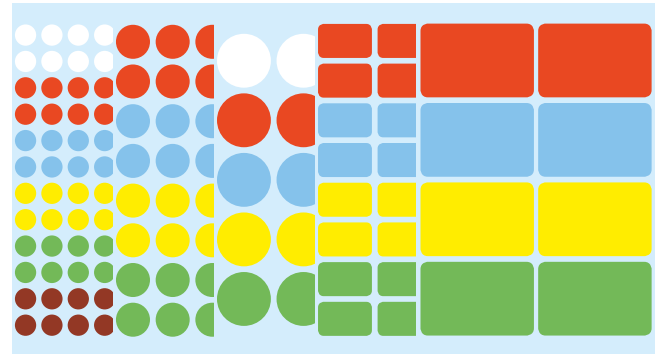

1831 1851 1881 3631 3681

Jewellery labels

Semi-cardboard, permanent adhesion			Office packs		
Label format (mm)	Description	Features	Labels/ sheet	Labels/ pack.	Ref. no.
10 x 49	<input type="checkbox"/> with ungummed centre section		24	600	2510

- Ideal for pricing rings, clocks, jewellery, glasses and small-diameter objects (e.g. cables)



Simply loop the non-adhesive middle section around the object. After the backing paper has been removed from the middle section, the jewellery labels adhere over the whole surface.

Seal labels

Polyester film, extra strong adhesive			Office packs		
Label format (mm)	Description	Features	Labels/ sheets	Labels/ pack.	Ref. no.
∅ 19	transparent, matt		40	640	2257
∅ 32	transparent, matt		15	240	2277
∅ 32	transparent, matt, perforated		15	240	2279

- For secure sealing of bulk merchandise etc., as original closure
- In office packs, sheet format approx. 111x170 mm



F FSC™-certified label material from responsibly managed forests

Index

	Page		Page		Page				
A	A3-size labels for PC printers	23. 45. 50	N	Name badges	43				
	A5-size labels for PC printers	23		Name labels	42				
	A6-size labels for PC printers	23		Neon labels	35. 47				
	Address labels for PC printers (A4)	20-23. 30-31	O	Opaque labels	24-26. 30. 52				
	Adhesive film. outdoor	45		Outdoor application/use	44-50				
Artificial silk. labels made of	42	Outdoor labels/adhesive film		45					
B	Bottle labels	39		Oval labels	32. 51				
	C	Cardboard inlays for CD/DVD		29	P	Perforated labels	37. 53		
		Cardboard inserts for name badges	43	Photo-Quality labels		38-41			
		Cardboard labels for files	43	Pictogram stickers		57			
		CD inlays. DVD inlays	29	Polyester film		46-51			
		CD labels	28	Polyethylene film		45			
		Climate-proof package	5	Positioning aid (CD labels)		28			
		Coloured dots for hand labelling	59-60	Power labels		33			
		Coloured labels	24-25. 34-35. 46	PREMIUM labels for general use / addressing		20-23			
		Correction/cover-up labels	52	Price/merchandise labelling		32. 52. 53			
		Covering labels	52	Processing instructions A4 labels		23. 44			
		Crystal clear labels	39. 50	Q		QR Code Labels	52		
		D	Data storage labels			28-29	R	Rating plates	48
			Deep-freeze labels			37		Recycled paper. labels made of	36
			Design templates		7	Removable labels		26. 30-32. 47	
			Diskette labels		29	Repositionable labels		26. 30-32	
			Durable labels	39. 44-51	Reusable labels	26. 30-32			
F	File spine insert cards	43	Robust tags	53					
	File spine labels	24-27	Round labels	32-33. 35. 46-47. 50					
	Film labels	39. 45-51	S	Sealing labels	49. 60				
	Folder labels	24-27		Security labels	49				
	Format overview	15-19		Self-adhesive film	45-51				
	Format templates for Word	7		Shelf labels	30-32				
G	General use. labels for	20-23. 54		Shipping label + delivery note	53				
	Glossy labels	39. 41		Shipping labels for PC printers	20-23. 30-31				
H	Hard-wearing labels	39. 44-51		Shipping or warning notes	53				
		High-gloss labels		39. 41	Signalling and notice labels	46			
		High-speed laser labels		20-23	Signalling signs. yellow film	34-35. 37			
		Home & office range		55-57	Silver film	48. 51			
		Hygiene information labels		58	Slide labels	29			
I	Identification labels	32. 53		Small packs	55-57				
		Impregnated labels		44	Software	6-7			
		Information labels		34-35. 53	Silphie paper, labels made of	37			
		Inkjet labels		38-40	Spine insert labels. cardboard	43			
		Inscription strips. removable		30-31	Spine labels for files	24-27. 43			
		Internetmarke - suitable labels		20-23, 30-31, 33, 36-38, 46, 52-53, 55	Square labels	32. 38. 46. 52			
		Inventory. labels for		33. 48	Storage media labels	28-29			
		J	Jewellery labels	52	Strong adhesive labels	33. 44-46. 48. 49			
				L	Label Assistant Online	6-7	Suspension files. labels for	25-26	
						Label software	6-7	T	Tab labels
Labels for envelopes and parcels	20-23. 30-31	Tags. for PC printers	54						
Laser Glossy Labels	41	Textile labels	42						
Labels made of silphie paper	37	Transparent labels	39. 50						
M	Mandatory/prohibitive information signs	58	U	Universal labels. labels for general use	20-23. 54				
		Marking dots for hand labelling			60-61	V	Video labels	29	
		Material overview	14	W	Warning labels (Covid)			58	
		Maxi. CD labels	28					Weatherproof film labels	45-51
		Multipurpose labels for hand lettering	59-61	Weatherproof shipping labels	46				

Catalogues online, always and everywhere with you!

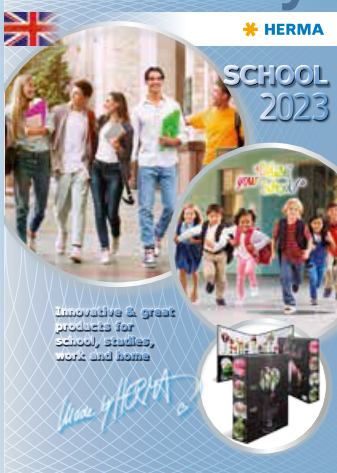

to the catalogues



Quick & informative

QR codes in the catalogue - discover, scan, experience!



For questions and orders:
verkaufsteam-handel@herma.de

HERMA GmbH
Heinrich-Hermann-Straße 14
70794 Filderstadt • Germany
www.herma.com

